



ST. TAMMANY PARISH

MICHAEL B. COOPER
PARISH PRESIDENT

NOTICE TO BIDDERS

ST. TAMMANY PARISH

Sealed bids will be received by the Department of Procurement, until 2:00 p.m., **Wednesday, July 7, 2021**, and then opened and read publicly at that time by the Procurement Staff for the following project:

Bid # 21-23-2– 2021 District Concrete Panel Replacements

Each paper bid must be submitted in a sealed envelope. The outside of the envelope shall show the Name and Address of the Bidder, the State Contractor's License Number of the Bidder (if the work is estimated at \$50k or more), the Bid Name and the Bid Number.

The project classification is:

Highway, Street and Bridge Construction

This bid package is available online at <http://www.stpgov.org/> or at www.bidexpress.com. It is the Vendor's responsibility to check the Parish website or bid express frequently for any possible addenda that may be issued. The Parish is not responsible for a Vendor's failure to download any addenda documents required to complete a submission.

It is the Bidder's responsibility to check the Parish website frequently for any possible addenda that may be issued. The Parish is not responsible for a Bidder's failure to download any addenda documents required to complete a submission.

Bids will be received at 21454 Koop Dr., Suite 2F, Mandeville, LA 70471 from each bidder or his agent and given a written receipt, by certified mail with return receipt requested, or electronically at www.bidexpress.com.

Procurement Department

BID PROPOSAL

ST. TAMMANY PARISH
GOVERNMENT



BID PACKAGE FOR

**2021 District Concrete Panel
Replacements**

BID NO.: 21-23-2

April 14, 2021

Section 01

Table of Contents

Section 01	Table of Contents
Section 02	Instructions to Bidders
Section 03	Summary of Work
Section 04	LA Uniform Public Work Bid Form Unit Price Form
Section 05	Affidavits, Louisiana (Pursuant to LSA-R.S. 38:2224, 38:2227 and 38:2212.10)
Section 06	Insurance Requirements
Section 07	Project Sign
Section 08	General Conditions
Section 09	Contract Time Extension
Section 10	Fiber-Reinforced Cement
Section 11	Testing and Inspection Standards/ Testing Records
Section 12	Roll Over Curb Details
Section 13	Concrete Replacement Details

Section 02

Instructions to Bidders

Bidders are urged to promptly review the requirements of this specification and submit questions for resolution as early as possible during the bid period. Questions or concerns must be submitted in writing to the Procurement Department no later than 2:00 CST seven (7) working days prior to the bid opening date. Otherwise, this will be construed as acceptance by the bidders that the intent of the specifications is clear and that competitive bids may be obtained as specified herein. Protests with regard to the specification documents will not be considered after bids are opened.

1. Bid security is required. Be sure that your bid includes such security as is necessary to meet Parish requirements and is properly signed. The bid must be fully completed. All applicable Louisiana license numbers must be affixed.
2. The Owner is the St. Tammany Parish Government (the "Parish").
3. The terms "he/his" and "it/its" may be used interchangeably.
4. The terms "Owner," the "Parish," and "St. Tammany Parish" may be used interchangeably.
5. The successful Bidder understands the limited contract time in the contract is **one hundred twenty (120) Calendar days + Calculated Rain Days per attached specifications**, and shall submit any request for an extension of time in accordance with the General and Supplementary Conditions. Said request will reflect the days requested and the reason for same. No extension request is guaranteed or absolute.
6. Bidder specifically understands that acknowledgment of the General Conditions is required. Bidder specifically understands that signature of receipt of the General Conditions is mandated. **The Bidder's signature on the "Louisiana Uniform Public Work Bid Form" will serve as acknowledgment of the Bidder's receipt and understanding of the General Conditions as well as any Supplementary Conditions.**
7. ***If any additional work is performed by the contractor without written approval by owner, the cost of the work will be borne by the contractor and will not be reimbursed by the Parish.***
8. **Only** the Louisiana Uniform Public Bid Form, the Unit Price Form (if necessary), the bid security, and written evidence of authority of person signing the bid shall be submitted on or before the bid opening time and date provided for in the Bid Documents. Necessary copies of the Louisiana Uniform Public Work Forms and Unit Price Forms (if necessary) will be furnished for Bidding. Bound sets of the Contract Documents are for Bidder's information and should not be used in submitting Bids.
9. All other documents and information required are to be submitted by the low Bidder within ten (10) days after the opening of the bids, and at the same time of day and location as given for the opening of the bids in the Bid Documents.
10. Each Bid must be submitted in a sealed envelope, unless submitted electronically. The outside of the envelope shall show the name and address of the Bidder, the State Contractor's License Number of the Bidder (if work requires contractor's license), and the Project name and the Bid number. In the case of an electronic bid proposal, a contractor may submit an authentic digital signature on the electronic bid proposal accompanied by the contractor's license number, Project name and the Bid number.
11. The price quoted for the Work shall be stated in words and figures on the Bid Form, and in figures only on the Unit Price Form. The price in the Bid shall include all costs necessary for the complete performance of the Work in full conformity with the conditions of the Contract Documents, and shall include all applicable Federal, State, Parish, Municipal or other taxes. The price bid for the items listed on the Unit Price Form will include the cost of all related items not listed, but which are normally required to do the type of Work bid.

12. The Bid shall be signed by the Bidder. The information required on the Louisiana Uniform Public Work Bid Form must be provided. Evidence of agency, corporate, or partnership authority is required and shall be provided in conformance with LSA-R.S. 38:2212(B).
13. Only a Contractor licensed by the State to do the type of Work as indicated on the Notice to Bidders can submit a Bid. The Bidder's signature on the Bid Form certifies that he holds an active license under the provisions of Chapter 24 of Louisiana Revised Statutes Title 37. Failure to be properly licensed constitutes authority for the Owner to reject the Bid.
14. Bidders shall not attach any conditions or provisions to the Bid. Any conditions or provisions so attached may, at the sole option of the Owner, cause rejection of the Bid.
15. A Bid Guarantee of five percent (5%) of the amount of the total Bid, including Alternates, must accompany the Proposal and, at the option of the Bidder, may be a cashier's check, certified check or a satisfactory Bid Bond. The Bid Guarantee must be attached to the Louisiana Uniform Public Work Bid Form. No Bid will be considered unless it is so guaranteed. Cashier's check or certified check must be made payable to the order of the Owner. Cash deposits will not be accepted. The Owner reserves the right to cash or deposit the cashier's check or certified check. Such guarantees shall be made payable to the Parish of St. Tammany. In accordance with LSA-R.S. 38:2218(C), if a bid bond is used, it shall be written by a surety or insurance company currently on the U.S. Department of the Treasury Financial Management Service list of approved bonding companies which is published annually in the Federal Register, or by a Louisiana domiciled insurance company with at least an A- rating in the latest printing of the A.M. Best's Key Rating Guide to write individual bonds up to ten percent of policyholders' surplus as shown in the A.M. Best's Key Rating Guide or by an insurance company in good standing licensed to write bid bonds which is either domiciled in Louisiana or owned by Louisiana residents. It is **not** required to be on any AIA form.
16. Bid securities of the three (3) lowest Bidders will be retained by the Owner until the Contract is executed or until final disposition is made of the Bids submitted. Bid securities of all other Bidders will be returned promptly after the canvas of Bids. Bids shall remain binding for forty-five (45) days after the date set for Bid Opening. The Parish shall act within the forty-five (45) days to award the contract to the lowest responsible bidder or reject all bids. However, the Parish and the lowest responsible bidder, by mutual written consent, may agree to extend the deadline for award by one or more extensions of thirty (30) calendar days. In the event the Owner issued the Letter of Award during this period, or any extension thereof, the Bid accepted shall continue to remain binding until the execution of the Contract.
17. A Proposal may be withdrawn at any time prior to the scheduled closing time for receipt of Bids, provided the request is in writing, executed by the Bidder or its duly authorized representative and is filed with the Owner prior to that time. When such a request is received, the Proposal will be returned to the Bidder unopened. A bid withdrawn under the provisions of LSA-R.S. 38:2214(C) cannot be resubmitted.
18. Written communications, over the signature of the Bidder, to modify Proposals will be accepted and the Proposal corrected in accordance therewith if received by the Owner prior to the scheduled closing time for receipt of Bids. Oral, telephonic or telegraphic Modifications will not be considered.
19. No oral interpretation obligating the Owner will be made to any Bidder as to the meaning of the Drawings, Specifications and Contract Documents. Every request for such an interpretation shall be made in writing and addressed and forwarded to the Owner. Inquiries received within seven (7) days prior to the day fixed for opening of the Bids may not be given consideration. Every interpretation made to the Bidder shall be in the form of an addendum to the Specifications. All such Addenda shall become part of the Contract Documents. Failure of the Owner to send or failure of Bidder to receive any such interpretation shall not relieve any Bidder from any obligation under this Bid as submitted without Modification. All Addenda shall be issued in accordance with the Public Bid Law, LSA-R.S. 38:2212(O).
20. The Owner reserves the right to reject any or all Bids for just cause in accordance with the Public Bid Law, LSA-R.S. 38:2214(B). Incomplete, informal, illegible, or unbalanced Bids may be rejected. Reasonable grounds for belief that any one Bidder is concerned directly or indirectly with more than one Bid will cause rejection of all Bids wherein such Bidder

is concerned. If required, a Bidder shall furnish satisfactory evidence of its competence and ability to perform the Work stipulated in its Proposal. Incompetence will constitute cause for rejection. If the Parish determines that the bidder is not responsive or responsible for any reason whatsoever, the bid may be rejected in accordance with State law.

21. The Contractor shall indemnify and hold harmless the Owner from any and all suits, costs, penalties or claims for infringement by reason of use or installation of any patented design, device, material or process, or any trademark and copyright in connection with the Work agreed to be performed under this Contract, and shall indemnify and hold harmless the Owner for any costs, expenses and damages which it may be obliged to pay by reason of any such infringement at any time during the prosecution or after completion of the Work.
22. Bidders shall familiarize themselves with and shall comply with all applicable Federal and State Laws, municipal ordinances and the rules and regulations of all authorities having jurisdiction over construction of the Project, which may directly or indirectly affect the Work or its prosecution. These laws and/or ordinances will be deemed to be included in the Contract, as though herein written in full.
23. Each Bidder shall visit the site of the proposed Work and fully acquaint itself with all surface and subsurface conditions as they may exist so that it may fully understand this Contract. Bidder shall also thoroughly examine and be familiar with drawings, Specifications and Contract Documents. The failure or omission of any Bidder to receive or examine any form, instrument, Drawing or document or to visit the site and acquaint itself with existing conditions shall in no way relieve any Bidder from any obligation with respect to its Bid and the responsibility in the premises.
24. The standard contract form enclosed with the Proposal documents is a prototype. It is enclosed with the Contract Documents for the guidance of the Owner and the Contractor. It has important legal consequences in all respects and consultation with an attorney is encouraged. Contractor shall be presumed to have consulted with its own independent legal counsel.
25. When one set of Contract plans show the Work to be performed by two or more prime Contractors, it is the responsibility of each Bidder to become knowledgeable of the Work to be performed by the other where the Work upon which this bid is submitted is shown to come into close proximity or in conflict with the Work of the other. In avoiding conflicts, pressure pipe lines must be installed to avoid conflict with gravity pipe lines and the Bidder of the smaller gravity pipe line in conflict with the larger gravity pipe line must include in his Bid the cost of a conflict box at these locations. The location of and a solution to the conflicts do not have to be specifically noted as such on the plans.
26. Bidder shall execute affidavit(s) attesting compliance with LSA-R.S. 38:2212.10, 38:2224, 38:2227, each as amended, and other affidavits as required by law, prior to execution of the contract.
27. Sealed Bids shall be delivered to St. Tammany Parish Government at the office of **St. Tammany Parish Government, Department of Procurement, 21454 Koop Drive, Suite 2-F, Mandeville, LA 70471**, and a receipt given, until the time and date denoted in Notice to Bidders, at which time and place the Bids shall be publicly opened and read aloud to those present. In accordance with LSA-R.S. 38:2212(H), the designer's final estimated cost of construction shall be read aloud upon opening bids. Sealed Bids may also be mailed by certified mail to **St. Tammany Parish Government, Department of Procurement, 21454 Koop Drive, Suite 2-F, Mandeville, LA 70471**, and must be received before the bid opening. Bids may also be submitted electronically. Information concerning links for electronic bidding is contained in the Notice to Bidders. It is the responsibility of the Bidders to insure that bids are delivered in a timely fashion. **Late bids, regardless of reason, will not be considered, and will be returned to bidder.**
28. Paper bids shall be placed in a sealed envelope, marked plainly and prominently as indicated in the Notice to Bidders, and these Instructions, and addressed:

**St. Tammany Parish Government
Department of Procurement
21454 Koop Drive, Suite 2-F
Mandeville, LA 70471**

29. Complete sets of Drawings, Specifications and Contract Documents may be secured at the Office of the Owner. See Notice to Bidders for deposit schedule and availability via electronic methods.
30. The successful Bidder shall be required to post in each direction a public information sign, 4' x 8' in size, at the location of the project containing information required by the Owner. The Owner shall supply this information.
31. The award of the Contract, if it is awarded, will be to the lowest responsible Bidder, in accordance with State Law. No award will be made until the Owner has concluded such investigations as it deems necessary to establish the responsibility, qualifications, and financial ability and stability of the Bidder to do the Work in accordance with the Contract Documents to the satisfaction of the Owner within the time prescribed as established by the Department based upon the amount of work to be performed and the conditions of same. The written contract and bond shall be issued in conformance with LSA-R.S. 38:2216. If the Contract is awarded, the Owner shall give the successful Bidder written notice of the award within forty-five (45) calendar days after the opening of the Bids in conformance with LSA-R.S. 38:2215(A), or any extension as authorized thereunder.
32. At least three days prior to the execution of the Contract, the Contractor shall deliver to the Owner the required Bonds.
33. Failure of the successful Bidder to execute the Contract and deliver the required Bonds within twenty (20) days of the Notice of the Award shall be just cause for the Owner to annul the award and declare the Bid and any guarantee thereof forfeited. Award may then be made to the next lowest responsible bidder.
34. In order to ensure the faithful performance of each and every condition, stipulation and requirement of the Contract and to indemnify and hold harmless the Owner from any and all damages, either directly or indirectly arising out of any failure to perform same, the successful Bidder to whom the Contract is awarded shall furnish a Performance and Payment Bond in an amount of at least equal to one hundred percent (100%) of the Contract Price. The Contract shall not be in force or binding upon the Owner until such satisfactory Bond has been provided to and approved by the Parish. The cost of the Bond shall be paid for by the Contractor unless otherwise stipulated in the Special Provisions.
35. No surety Company will be accepted as a bondsman which has no permanent agent or representative in the State upon whom notices referred to in the General Conditions of these Specifications may be served. Service of said notice on said agent or representative in the State shall be equal to service of notice on the President of the Surety Company, or such other officer as may be concerned.
36. In conformance with LSA-R.S. 38:2219(A)(1)(a), (b), and (c):

Any surety bond written for a public works project shall be written by a surety or insurance company currently on the U.S. Department of the Treasury Financial Management Service list of approved bonding companies which is published annually in the Federal Register, or by a Louisiana domiciled insurance company with at least an A- rating in the latest printing of the A.M. Best's Key Rating Guide, to write individual bonds up to ten percent of policyholders' surplus as shown in the A.M. Best's Key Rating Guide or by an insurance company that is either domiciled in Louisiana or owned by Louisiana residents and is licensed to write surety bonds.

For any public works project, no surety or insurance company shall write a bond which is in excess of the amount indicated as approved by the U.S. Department of the Treasury Financial Management Service list or by a Louisiana domiciled insurance company with an A- rating by A.M. Best up to a limit of ten percent of policyholders' surplus as shown by A.M. Best; companies authorized by this Paragraph who are not on the treasury list shall not write a bond when the penalty exceeds fifteen percent of its capital and surplus, such capital and surplus being the amount by which the company's assets exceed its liabilities as reflected by the most recent financial statements filed by the company with the Department of Insurance.

In addition, any surety bond written for a public works project shall be written by a surety or insurance company that is currently licensed to do business in the state

of Louisiana. All contractors must comply with any other applicable provisions of LSA-R.S. 38:2219.

37. Should the Contractor's Surety, even though approved and accepted by the Owner, subsequently remove its agency or representative from the State or become insolvent, bankrupt, or otherwise fail, the Contractor shall immediately furnish a new Bond in another company approved by the Owner, at no cost to the Owner. The new Bond shall be executed under the same terms and conditions as the original Bond. The new bond shall be submitted within thirty (30) days of such time as the Owner notifies Contractor or from the time Contractor learns or has reason to know that the original surety is no longer financially viable or acceptable to the Parish, whichever occurs first. In the event that Contractor fails or refuses to timely secure additional surety, then the Owner may secure such surety and thereafter deduct such cost or expense from any sum due, or to become due to Contractor.
38. The Contractor's bondsman shall obligate itself to all the terms and covenants of these Specifications and of contracts covering the Work executed hereunder. The Owner reserves the right to do Extra Work or make changes by altering, adding to deducting from the Work under the conditions and in the manner herein before described without notice to the Contractor's surety and without in any manner affecting the liability of bondsman or releasing it from any of its obligations hereunder.
39. The Bond shall also secure for the Owner the faithful performance of the Contract in strict accordance with plans, specifications, and other Contract Documents. It shall protect the Owner against all lien laws of the State and shall provide for payment of reasonable attorney's fees for enforcement of Contract and institution or concursus proceedings, if such proceedings become necessary. Likewise, it shall provide for all additional expenses of the Owner occurring through failure of the Contractor to perform.
40. The surety of the Contractor shall be and does hereby declare and acknowledge itself by acceptance to be bound to the Owner as a guarantor, jointly and in solido, with the Contractor, for fulfillment of terms of the Contract.
41. The performance Bond and Labor and Material Bond forming part of this Contract shall be continued by Contractor and its Surety for a period of one (1) year from date of acceptance of the Work/Project by Owner to assure prompt removal and replacement of all defective material, equipment, components thereof, workmanship, etc., and to assure payment of any damage to property of Owner or others as a result of such defective materials, equipment, workmanship, etc.
42. Contractor shall pay for cost of recording the Contract, Bond, and any change orders required to be recorded, as well as the cost of canceling any of the foregoing. Contractor shall also secure and pay for all Clear Lien and Privilege Certificates (together with any updates) which will be required before any final payment is made, and that may be required before any payment, at the request of the Owner, its representative, agent, architect, engineer and the like. All recordation and Clear Lien and Privilege Certificate requirements shall be in accordance with those requirements noted herein before in contract Specifications.
43. Contractor shall secure and maintain at its expense such insurance that will protect it and the Parish from claims for injuries to persons or damages to property which may arise from or in connection with the performance of Services or Work hereunder by the Contractor, his agents, representatives, employees, and/or subcontractors. The cost of such insurance shall be included in Contractor's bid.
44. The Contractor shall not commence work until it has obtained all insurance as required for the Parish Project. If the Contractor fails to furnish the Parish with the insurance protection required and begins work without first furnishing Parish with a currently dated certificate of insurance, the Parish has the right to obtain the insurance protection required and deduct the cost of insurance from the first payment due the Contractor. Further deductions are permitted from future payments as are needed to protect the interests of the Parish including, but not limited to, renewals of all policies.
45. Payment of Premiums: The insurance companies issuing the policy or policies shall have no recourse against the Parish of St. Tammany for payment of any premiums or for assessments under any form of policy.

46. Deductibles: Any and all deductibles in the described insurance policies shall be assumed by and be at the sole risk of the Contractor.
47. Authorization of Insurance Company(ies) and Rating: All insurance companies must be authorized to do business in the State of Louisiana and shall have an A.M. Best rating of no less than A-, Category VII.
48. Policy coverages and limits must be evidenced by Certificates of Insurance issued by Contractor's carrier to the Parish and shall reflect:

Date of Issue: Certificate must have current date.

Named Insured: The legal name of Contractor under contract with the Parish and its principal place of business shall be shown as the named insured on all Certificates of Liability Insurance.

Name of Certificate Holder: St. Tammany Parish Government, Office of Risk Management, P. O. Box 628, Covington, LA 70434

Project Description: A brief project description, including Project Name, Project Number and/or Contract Number, and Location.

Endorsements and Certificate Reference: All policies must be endorsed to provide, and certificates of insurance must evidence the following:

Waiver of Subrogation: The Contractor's insurers will have no right of recovery or subrogation against the Parish of St. Tammany, it being the intention of the parties that all insurance policy(ies) so affected shall protect both parties and be the primary coverage for any and all losses covered by the below described insurance. *Policy endorsements required for all coverages.*

Additional Insured: The Parish of St. Tammany shall be named as additional named insured with respect to general liability, marine liability, pollution/environmental liability, automobile liability and excess liability coverages. *Policy endorsements required.*

Hold Harmless: Contractor's liability insurers shall evidence their cognizance of the Hold Harmless and Indemnification in favor of St. Tammany Parish Government by referencing same on the face of the Certificate(s) of Insurance.

Cancellation Notice: Producer shall provide thirty (30) days prior written notice to the Parish of policy cancellation or substantive policy change.

49. The types of insurance coverage the Contractor is required to obtain and maintain throughout the duration of the Contract shall be designated by a separate document issued by the Office of Risk Management.
50. It is the intent of these instructions that they are in conformance with State Bid Laws. Should there be any discrepancy or ambiguity in these provisions, the applicable State Bid Law shall apply.
51. The letting of any public contract in connection with funds that are granted or advanced by the United States of America shall be subject to the effect, if any, of related laws of said United States and valid rules and regulations of federal agencies in charge, or governing use and payment of such federal funds.
52. Protests based on alleged solicitation improprieties that are apparent before bid opening, or the time set for receipt of initial proposals must be filed with and received by the Procurement Department BEFORE these times. Any other protest shall be filed no later than ten (10) calendar days after: the opening of the bid; the basis of the protest is known; or the basis of the protest should have been known (whichever is earlier).
53. It is the Parish's policy to provide a method to protest exclusion from a competition or from the award of a contract, or to challenge an alleged solicitation irregularity. It is always

better to seek a resolution within the Parish system before resorting to outside agencies and/or litigation to resolve differences. All protests must be made in writing, and shall be concise and logically presented to facilitate review by the Parish. The written protest shall include:

The protester's name, address, and fax and telephone numbers and the solicitation, bid, or contract number;

A detailed statement of its legal and factual grounds, including a description of the resulting prejudice to the protester;

Copies of relevant documents;

All information establishing that the protester is an interested party and that the protest is timely; and

A request for a ruling by the agency; and a statement of the form of relief requested.

The protest shall be addressed to St. Tammany Parish Government Department of Procurement, P.O. Box 628, Covington, LA 70434

The protest review shall be conducted by the Parish Legal Department.

Only protests from interested parties will be allowed. Protests based on alleged solicitation improprieties that are apparent before bid opening, or the time set for receipt of initial proposals, must be filed with and received by the Department of Procurement BEFORE those deadlines.

Any other protest shall be filed no later than ten (10) calendar days after the basis of the protest is known, or should have been known (whichever is earlier).

The Parish will use its best efforts to resolve the protest within thirty (30) days of the date that it is received by the Parish. The written response will be sent to the protestor via mail and fax, if a fax number has been provided by the protestor. The protester can request additional methods of notification.

54. The last day to submit questions and/or verification on comparable products will be no later than 2:00 pm CST, seven (7) working days prior to the opening date of the bid/proposal due date. Further, any questions or inquires must be submitted via fax to 985-898-5227, or via email to Purchasing@stpgov.org. Any questions or inquiries received after the required deadline to submit questions or inquiries will not be answered.
55. St. Tammany Parish Government contracts to be awarded are dependent on the available funding and/or approval by members designated and/or acknowledged by St. Tammany Parish Government. At any time St. Tammany Parish Government reserves the right to cancel the award of a contract if either or both of these factors is deficient.
56. Any action by the Parish to disqualify any Bidder on the grounds that they are not a responsible Bidder shall be conducted in accordance with LSA-R.S. 38:2212(X).
57. If any part of the provisions contained herein and/or in the Specifications and Contract for the Work shall for any reason be held invalid, illegal or unenforceable in any respect, such invalidity, illegality or unenforceability shall not affect any other provisions of this Agreement or attachment, but it shall be construed as if such invalid, illegal, or unenforceable provision or part of a provision had never been contained herein.

Section 03

Summary of Work

I. Work to Include:

The Contractor must provide all adequate and competent labor, equipment, tools, testing, and materials necessary to improve roadways by removing/replacing/repairing concrete panels and curbs as specified along Tallow Creek Blvd (R01C027) Section 1 Township 7S Range 10E Covington ; Avenue Louis Quatorze (R03A020) Section 16 Township 7S Range 11E Covington ; Avenue Lacroix (R03A036) Section 17 Township 7S Range 11E Covington ; Avenue Saint Albert (R03A021) Section 16 Township 7S Range 11E Covington ; Thackery St (R04D142) Section 27 Township 7S Range 11E Covington ; Bluefield Dr (R08I061) Section 25 Township 8S Range 14E Slidell ; Lake Village Blvd (R08L026) Section 36 Township 8S Range 15E Slidell ; Lenwood Dr (R08I132) Section 25 Township 8S Range 13E Slidell ; Northwood Dr (R08I030) Section 25 Township 8S Range 14E Slidell ; Greenleaves Blvd (R04D060) Section 1 Township 7S Range 11E Covington ; Oak Harbor Blvd (R09J090) Section 44 Township 9S Range 14E Slidell ; Brookter St (R08V108) Section 24 Township 9S Range 14E Slidell ; Drury Ln (R09G037) Section 38 Township 9S Range 14E Slidell ; Foxbriar St (R08V020) Section 13 Township 9S Range 14E Slidell ; Heather Ln (R08V048) Section 24 Township 9S Range 14E Slidell ; Portsmouth Dr (R09G039) Section 38 Township 9S Range 14E Slidell ; Raleigh St (R09G036) Section 38 Township 9S Range 14E Slidell ; Westminster Dr (R09G033) Section 38 Township 9S Range 14E Slidell.

II. Location of Work:

Tallow Creek Blvd (R01C027) Section 1 Township 7S Range 10E Covington ; Avenue Louis Quatorze (R03A020) Section 16 Township 7S Range 11E Covington ; Avenue Lacroix (R03A036) Section 17 Township 7S Range 11E Covington ; Avenue Saint Albert (R03A021) Section 16 Township 7S Range 11E Covington ; Thackery St (R04D142) Section 27 Township 7S Range 11E Covington ; Bluefield Dr (R08I061) Section 25 Township 8S Range 14E Slidell ; Lake Village Blvd (R08L026) Section 36 Township 8S Range 15E Slidell ; Lenwood Dr (R08I132) Section 25 Township 8S Range 13E Slidell ; Northwood Dr (R08I030) Section 25 Township 8S Range 14E Slidell ; Greenleaves Blvd (R04D060) Section 1 Township 7S Range 11E Covington ; Oak Harbor Blvd (R09J090) Section 44 Township 9S Range 14E Slidell ; Brookter St (R08V108) Section 24 Township 9S Range 14E Slidell ; Drury Ln (R09G037) Section 38 Township 9S Range 14E Slidell ; Foxbriar St (R08V020) Section 13 Township 9S Range 14E Slidell ; Heather Ln (R08V048) Section 24 Township 9S Range 14E Slidell ; Portsmouth Dr (R09G039) Section 38 Township 9S Range 14E Slidell ; Raleigh St (R09G036) Section 38 Township 9S Range 14E Slidell ; Westminster Dr (R09G033) Section 38 Township 9S Range 14E Slidell

III. Documents: Bid Documents dated April 14, 2021, and entitled:

2021 District Concrete Panel Replacements
Bid #21-23-2

IV. OTHER REQUIREMENTS (as applicable)

When not otherwise specified herein, all work and materials shall conform to the requirements of the Louisiana Department of Transportation and Development hereafter called LDOTD (2006 Edition of Louisiana Standard Specifications for Roads and Bridges).

Panels will be marked in the field once project is ready to begin.

Item	Description	Length	Width	Quantity	Unit
	<p>General Notes:</p> <ol style="list-style-type: none"> 1. Contractor shall field verify all quantities and measurements. 2. Contractor shall be responsible for locating and protecting all existing utilities. 3. Two-way traffic shall be maintained at all times during construction. Contractor shall have flagmen on both ends of work zone. If Police details are used for traffic control this does not take the place of flag men. 4. Construction work shall not begin until signs, barricades, project signs and other traffic devices have been erected and approved. Contractor shall maintain project and construction signs. 5. All existing sewer lines shall be tied-in at no direct pay. 6. Asphalt and concrete driveway tie-ins shall be tied in to existing surface material. 7. Any additional work performed by the contractor without prior written approval from St Tammany Parish Department of Engineering, the cost of the work will be borne by the contractor and will not be reimbursed by the Parish. 8. Contractor shall ensure roadway and shoulders drain accordingly without any surface ponding/"bird baths" after rain events. 9. Materials Testing: All required testing and reporting shall be the contractor's responsibility at no direct pay. Sampling and Testing will be performed in accordance with the St. Tammany Parish Roadway Testing and Inspection Standards for Residential Subdivisions (Attached with Bid Proposal) and LADOTD Standard Specifications for Roads and Bridges, Latest Edition, Section 101 and 106. 10. Roads and surrounding areas shall be dressed after 7 calendar days and no later than 10 calendar days after opening of street. Late Fee of \$1.00 per Linear Foot per Calendar Day shall be charged if not completed with the specified time frame. 11. If any driveways are impacted, contractor shall give resident 24 hour notice that they need to move vehicles so as to not get blocked in and that they will not be able to access the driveway for three days after pouring concrete. 				
	<p>Project Summary: Contractor shall provide all labor, materials, equipment and supervision necessary to Remove, Replace and/or Repair Concrete Panels and Concrete Rollover/Barrier Curbs.</p>				
727-01	<p>Mobilization: All labor and materials necessary to accomplish preparatory work and operations, including those necessary for movement of personnel, equipment, supplies and incidentals to the project site.</p>			1	Lump Sum

All Work Shall Conform to Louisiana Standard Specifications for Roads and Bridges, Latest Edition

Panels will be marked in the field once project is ready to begin.

Item	Description	Length	Width	Quantity	Unit
713-01	Temporary Signs and Barricades: All labor, materials, equipment and supervision necessary to furnish, install, maintain and remove temporary construction barricades, precast concrete barriers, lights, signals, pavement markings and signs, including project signs ; providing flaggers; and complying with all other requirements regarding the protection of the work, workers and safety of the public. Unless otherwise noted in the plans or special provisions this work also includes traffic control management in compliance with contract documents and the Manual on Uniform Traffic Control Devices (MUTCD), including the installation, inspection, maintenance, and removal of all traffic control devices on the project. This item shall not be construed to relieve the contractor of responsibilities for the safety of the public, for liability in connection therewith, or compliance with State and local laws or ordinances. Signs, barricades, barriers, channelizing devices, pavement markings, etc., shall comply with plan details, the MUTCD and Section 713 of LADOTD Standard Specifications for Roads and Bridges, Latest Edition. Construction work shall not begin until signs, barricades, project signs and other traffic devices have been erected and approved.			1	Lump Sum
S-00001	Sawcutting (Concrete): All Labor, Materials, equipment, and supervision necessary to cut full depth concrete road panels. This item is separate and apart from cutting the joints of the road to prevent damaging another panel that is scheduled to remain.			100	IN/FT
715-01-00100	Topsoil Shoulder Material: LA DOTD Standard Specification for Roads and Bridges, Section 401. All labor, materials and equipment necessary to furnish and place Topsoil for shoulder material (Adjusted Vehicular Measurement). Contractor shall place specified shoulder material flush with the asphalt wearing surface course to a maximum of 12" wide. This material shall be graded uniformly throughout the project. Should any excess incidental construction material extend beyond the 12" maximum limit, the material shall be removed and properly disposed of off-site. The finished specified shoulder material shall not consist of any foreign material that is not contained with the parent material.			2	Cubic Yard

All Work Shall Conform to Louisiana Standard Specifications for Roads and Bridges, Latest Edition

Panels will be marked in the field once project is ready to begin.

Item	Description	Length	Width	Quantity	Unit
706-03-00500	<p>Remove/Replace/Repair Concrete Panels: All labor, materials, equipment and supervision necessary to, in accordance with these specifications, and LA DOTD Standard Specifications for Roads and Bridges, Section 706 Latest Edition, Remove/Replace/Repair Concrete Pavement. Contractor shall be responsible for removal of concrete, curbing, and all base materials to a depth of 8" below the bottom grade of the new 8" thick concrete panel. Replacement base material shall be River Sand or Pumped Sand. Base repair and/or patch is not limited to a square yardage quantity, but may include the entire panel if directed by Department of Public Works inspection staff. This item is at no direct pay. Prior to contractor pouring replacement concrete panel and rollover curb, base material shall be examined by project inspector. Contractor shall inspect the project site and bid accordingly. Panels identified for removal and replacement next to and/or adjacent to new panels shall be saw-cut along the adjoining edge. Any damage caused by contractor operations shall be repaired immediately at no direct pay.</p> <p>Replacement panels shall be Fiber reinforced, 4000 psi, 8" thick concrete, with 3/4" smooth dowel bars into existing concrete pavement @ 18" on-center for butt/construction joints. Use #4 deformed bar for longitudinal joints 2' on center. Panels longer than 15' in length shall be split into two panels by means of keyway and load transfer bars.</p> <p>Joints shall be replaced in-kind, to include but not limited to expansion joints, control joints, etc., and sealed with approved joint sealing material.</p> <p>Broken concrete shall be removed and hauled to an area identified by project inspector at no direct pay.</p>			165	Square Yard

All Work Shall Conform to Louisiana Standard Specifications for Roads and Bridges, Latest Edition

Panels will be marked in the field once project is ready to begin.

Item	Description	Length	Width	Quantity	Unit
<p>706-03-00500-A</p>	<p>Remove/Replace/Repair Concrete Panels (High Early): All labor, materials, equipment and supervision necessary to, in accordance with these specifications, and LA DOTD Standard Specifications for Roads and Bridges, Section 706 Latest Edition, Remove/Replace/Repair Concrete Pavement. Contractor shall be responsible for removal of concrete, curbing, and all base materials to a depth of 8" below the bottom grade of the new 8" thick concrete panel. Replacement base material shall be River Sand or Pumped Sand. Base repair and/or patch is not limited to a square yardage quantity, but may include the entire panel if directed by Department of Public Works inspection staff. This item is at no direct pay. Prior to contractor pouring replacement concrete panel and rollover curb, base material shall be examined by project inspector. Contractor shall inspect the project site and bid accordingly. Panels identified for removal and replacement next to and/or adjacent to new panels shall be saw-cut along the adjoining edge. Any damage caused by contractor operations shall be repaired immediately at no direct pay.</p> <p>Replacement panels shall be Fiber reinforced, 4000 psi @ 72 Hours, 8" thick concrete, with 3/4" smooth dowel bars into existing concrete pavement @ 18" on-center for butt/construction joints. Use #4 deformed bar for longitudinal joints 2' on center. Panels longer than 15' in length shall be split into two panels by means of keyway and load transfer bars.</p> <p>Joints shall be replaced in-kind, to include but not limited to expansion joints, control joints, etc., and sealed with approved joint sealing material.</p> <p>Broken concrete shall be removed and hauled to an area identified by project inspector at no direct pay.</p>			<p>60</p>	<p>Square Yard</p>

All Work Shall Conform to Louisiana Standard Specifications for Roads and Bridges, Latest Edition

Panels will be marked in the field once project is ready to begin.

Item	Description	Length	Width	Quantity	Unit
	<p>General Notes:</p> <ol style="list-style-type: none"> 1. Contractor shall field verify all quantities and measurements. 2. Contractor shall be responsible for locating and protecting all existing utilities. 3. Two-way traffic shall be maintained at all times during construction. Contractor shall have flagmen on both ends of work zone. If Police details are used for traffic control this does not take the place of flag men. 4. Construction work shall not begin until signs, barricades, project signs and other traffic devices have been erected and approved. Contractor shall maintain project and construction signs. 5. All existing sewer lines shall be tied-in at no direct pay. 6. Asphalt and concrete driveway tie-ins shall be tied in to existing surface material. 7. Any additional work performed by the contractor without prior written approval from St Tammany Parish Department of Engineering, the cost of the work will be borne by the contractor and will not be reimbursed by the Parish. 8. Contractor shall ensure roadway and shoulders drain accordingly without any surface ponding/"bird baths" after rain events. 9. Materials Testing: All required testing and reporting shall be the contractor's responsibility at no direct pay. Sampling and Testing will be performed in accordance with the St. Tammany Parish Roadway Testing and Inspection Standards for Residential Subdivisions (Attached with Bid Proposal) and LADOTD Standard Specifications for Roads and Bridges, Latest Edition, Section 101 and 106. 10. Roads and surrounding areas shall be dressed after 7 calendar days and no later than 10 calendar days after opening of street. Late Fee of \$1.00 per Linear Foot per Calendar Day shall be charged if not completed with the specified time frame. 11. If any driveways are impacted, contractor shall give resident 24 hour notice that they need to move vehicles so as to not get blocked in and that they will not be able to access the driveway for three days after pouring concrete. 				
	<p>Project Summary: Contractor shall provide all labor, materials, equipment and supervision necessary to Remove, Replace and/or Repair Concrete Panels and Concrete Rollover/Barrier Curbs.</p>				
727-01	<p>Mobilization: All labor and materials necessary to accomplish preparatory work and operations, including those necessary for movement of personnel, equipment, supplies and incidentals to the project site.</p>			1	Lump Sum

All Work Shall Conform to Louisiana Standard Specifications for Roads and Bridges, Latest Edition

Panels will be marked in the field once project is ready to begin.

Item	Description	Length	Width	Quantity	Unit
713-01	<p>Temporary Signs and Barricades: All labor, materials, equipment and supervision necessary to furnish, install, maintain and remove temporary construction barricades, precast concrete barriers, lights, signals, pavement markings and signs, including project signs; providing flaggers; and complying with all other requirements regarding the protection of the work, workers and safety of the public. Unless otherwise noted in the plans or special provisions this work also includes traffic control management in compliance with contract documents and the Manual on Uniform Traffic Control Devices (MUTCD), including the installation, inspection, maintenance, and removal of all traffic control devices on the project. This item shall not be construed to relieve the contractor of responsibilities for the safety of the public, for liability in connection therewith, or compliance with State and local laws or ordinances. Signs, barricades, barriers, channelizing devices, pavement markings, etc., shall comply with plan details, the MUTCD and Section 713 of LADOTD Standard Specifications for Roads and Bridges, Latest Edition. Construction work shall not begin until signs, barricades, project signs and other traffic devices have been erected and approved.</p>			1	Lump Sum
S-00001	<p>Sawcutting (Concrete): All Labor, Materials, equipment, and supervision necessary to cut full depth concrete road panels. This item is separate and apart from cutting the joints of the road to prevent damaging another panel that is scheduled to remain.</p>			100	IN/FT
715-01-00100	<p>Topsoil Shoulder Material: LA DOTD Standard Specification for Roads and Bridges, Section 401. All labor, materials and equipment necessary to furnish and place Topsoil for shoulder material (Adjusted Vehicular Measurement). Contractor shall place specified shoulder material flush with the asphalt wearing surface course to a maximum of 12" wide. This material shall be graded uniformly throughout the project. Should any excess incidental construction material extend beyond the 12" maximum limit, the material shall be removed and properly disposed of off-site. The finished specified shoulder material shall not consist of any foreign material that is not contained with the parent material.</p>			2	Cubic Yard

All Work Shall Conform to Louisiana Standard Specifications for Roads and Bridges, Latest Edition

Panels will be marked in the field once project is ready to begin.

Item	Description	Length	Width	Quantity	Unit
<p>706-03-00500</p>	<p>Remove/Replace/Repair Concrete Panels: All labor, materials, equipment and supervision necessary to, in accordance with these specifications, and LA DOTD Standard Specifications for Roads and Bridges, Section 706 Latest Edition, Remove/Replace/Repair Concrete Pavement. Contractor shall be responsible for removal of concrete, curbing, and all base materials to a depth of 8" below the bottom grade of the new 8" thick concrete panel. Replacement base material shall be River Sand or Pumped Sand. Base repair and/or patch is not limited to a square yardage quantity, but may include the entire panel if directed by Department of Public Works inspection staff. This item is at no direct pay. Prior to contractor pouring replacement concrete panel and rollover curb, base material shall be examined by project inspector. Contractor shall inspect the project site and bid accordingly. Panels identified for removal and replacement next to and/or adjacent to new panels shall be saw-cut along the adjoining edge. Any damage caused by contractor operations shall be repaired immediately at no direct pay.</p> <p>Replacement panels shall be Fiber reinforced, 4000 psi, 8" thick concrete, with 3/4" smooth dowel bars into existing concrete pavement @ 18" on-center for butt/construction joints. Use #4 deformed bar for longitudinal joints 2' on center. Panels longer than 15' in length shall be split into two panels by means of keyway and load transfer bars.</p> <p>Joints shall be replaced in-kind, to include but not limited to expansion joints, control joints, etc., and sealed with approved joint sealing material.</p> <p>Broken concrete shall be removed and hauled to an area identified by project inspector at no direct pay.</p>			<p>145</p>	<p>Square Yard</p>

All Work Shall Conform to Louisiana Standard Specifications for Roads and Bridges, Latest Edition

Panels will be marked in the field once project is ready to begin.

Item	Description	Length	Width	Quantity	Unit
<p>706-03-00500-A</p>	<p>Remove/Replace/Repair Concrete Panels (High Early): All labor, materials, equipment and supervision necessary to, in accordance with these specifications, and LA DOTD Standard Specifications for Roads and Bridges, Section 706 Latest Edition, Remove/Replace/Repair Concrete Pavement. Contractor shall be responsible for removal of concrete, curbing, and all base materials to a depth of 8" below the bottom grade of the new 8" thick concrete panel. Replacement base material shall be River Sand or Pumped Sand. Base repair and/or patch is not limited to a square yardage quantity, but may include the entire panel if directed by Department of Public Works inspection staff. This item is at no direct pay. Prior to contractor pouring replacement concrete panel and rollover curb, base material shall be examined by project inspector. Contractor shall inspect the project site and bid accordingly. Panels identified for removal and replacement next to and/or adjacent to new panels shall be saw-cut along the adjoining edge. Any damage caused by contractor operations shall be repaired immediately at no direct pay.</p> <p>Replacement panels shall be Fiber reinforced, 4000 psi @ 72 Hours, 8" thick concrete, with 3/4" smooth dowel bars into existing concrete pavement @ 18" on-center for butt/construction joints. Use #4 deformed bar for longitudinal joints 2' on center. Panels longer than 15' in length shall be split into two panels by means of keyway and load transfer bars.</p> <p>Joints shall be replaced in-kind, to include but not limited to expansion joints, control joints, etc., and sealed with approved joint sealing material.</p> <p>Broken concrete shall be removed and hauled to an area identified by project inspector at no direct pay.</p>			<p>50</p>	<p>Square Yard</p>

All Work Shall Conform to Louisiana Standard Specifications for Roads and Bridges, Latest Edition

Panels will be marked in the field once project is ready to begin.

Item	Description	Length	Width	Quantity	Unit
	<p>General Notes:</p> <ol style="list-style-type: none"> 1. Contractor shall field verify all quantities and measurements. 2. Contractor shall be responsible for locating and protecting all existing utilities. 3. Two-way traffic shall be maintained at all times during construction. Contractor shall have flagmen on both ends of work zone. If Police details are used for traffic control this does not take the place of flag men. 4. Construction work shall not begin until signs, barricades, project signs and other traffic devices have been erected and approved. Contractor shall maintain project and construction signs. 5. All existing sewer lines shall be tied-in at no direct pay. 6. Asphalt and concrete driveway tie-ins shall be tied in to existing surface material. 7. Any additional work performed by the contractor without prior written approval from St Tammany Parish Department of Engineering, the cost of the work will be borne by the contractor and will not be reimbursed by the Parish. 8. Contractor shall ensure roadway and shoulders drain accordingly without any surface ponding/"bird baths" after rain events. 9. Materials Testing: All required testing and reporting shall be the contractor's responsibility at no direct pay. Sampling and Testing will be performed in accordance with the St. Tammany Parish Roadway Testing and Inspection Standards for Residential Subdivisions (Attached with Bid Proposal) and LADOTD Standard Specifications for Roads and Bridges, Latest Edition, Section 101 and 106. 10. Roads and surrounding areas shall be dressed after 7 calendar days and no later than 10 calendar days after opening of street. Late Fee of \$1.00 per Linear Foot per Calendar Day shall be charged if not completed with the specified time frame. 11. If any driveways are impacted, contractor shall give resident 24 hour notice that they need to move vehicles so as to not get blocked in and that they will not be able to access the driveway for three days after pouring concrete. 				
	<p>Project Summary: Contractor shall provide all labor, materials, equipment and supervision necessary to Remove, Replace and/or Repair Concrete Panels and Concrete Rollover/Barrier Curbs.</p>				
727-01	<p>Mobilization: All labor and materials necessary to accomplish preparatory work and operations, including those necessary for movement of personnel, equipment, supplies and incidentals to the project site.</p>			1	Lump Sum

All Work Shall Conform to Louisiana Standard Specifications for Roads and Bridges, Latest Edition

Panels will be marked in the field once project is ready to begin.

Item	Description	Length	Width	Quantity	Unit
713-01	<p>Temporary Signs and Barricades: All labor, materials, equipment and supervision necessary to furnish, install, maintain and remove temporary construction barricades, precast concrete barriers, lights, signals, pavement markings and signs, including project signs; providing flaggers; and complying with all other requirements regarding the protection of the work, workers and safety of the public. Unless otherwise noted in the plans or special provisions this work also includes traffic control management in compliance with contract documents and the Manual on Uniform Traffic Control Devices (MUTCD), including the installation, inspection, maintenance, and removal of all traffic control devices on the project. This item shall not be construed to relieve the contractor of responsibilities for the safety of the public, for liability in connection therewith, or compliance with State and local laws or ordinances. Signs, barricades, barriers, channelizing devices, pavement markings, etc., shall comply with plan details, the MUTCD and Section 713 of LADOTD Standard Specifications for Roads and Bridges, Latest Edition. Construction work shall not begin until signs, barricades, project signs and other traffic devices have been erected and approved.</p>			1	Lump Sum
S-00001	<p>Sawcutting (Concrete): All Labor, Materials, equipment, and supervision necessary to cut full depth concrete road panels. This item is separate and apart from cutting the joints of the road to prevent damaging another panel that is scheduled to remain.</p>			100	IN/FT
715-01-00100	<p>Topsoil Shoulder Material: LA DOTD Standard Specification for Roads and Bridges, Section 401. All labor, materials and equipment necessary to furnish and place Topsoil for shoulder material (Adjusted Vehicular Measurement). Contractor shall place specified shoulder material flush with the asphalt wearing surface course to a maximum of 12" wide. This material shall be graded uniformly throughout the project. Should any excess incidental construction material extend beyond the 12" maximum limit, the material shall be removed and properly disposed of off-site. The finished specified shoulder material shall not consist of any foreign material that is not contained with the parent material.</p>			2	Cubic Yard

All Work Shall Conform to Louisiana Standard Specifications for Roads and Bridges, Latest Edition

Panels will be marked in the field once project is ready to begin.

Item	Description	Length	Width	Quantity	Unit
706-03-00500	<p>Remove/Replace/Repair Concrete Panels: All labor, materials, equipment and supervision necessary to, in accordance with these specifications, and LA DOTD Standard Specifications for Roads and Bridges, Section 706 Latest Edition, Remove/Replace/Repair Concrete Pavement. Contractor shall be responsible for removal of concrete, curbing, and all base materials to a depth of 8" below the bottom grade of the new 8" thick concrete panel. Replacement base material shall be River Sand or Pumped Sand. Base repair and/or patch is not limited to a square yardage quantity, but may include the entire panel if directed by Department of Public Works inspection staff. This item is at no direct pay. Prior to contractor pouring replacement concrete panel and rollover curb, base material shall be examined by project inspector. Contractor shall inspect the project site and bid accordingly. Panels identified for removal and replacement next to and/or adjacent to new panels shall be saw-cut along the adjoining edge. Any damage caused by contractor operations shall be repaired immediately at no direct pay.</p> <p>Replacement panels shall be Fiber reinforced, 4000 psi, 8" thick concrete, with 3/4" smooth dowel bars into existing concrete pavement @ 18" on-center for butt/construction joints. Use #4 deformed bar for longitudinal joints 2' on center. Panels longer than 15' in length shall be split into two panels by means of keyway and load transfer bars. Joints shall be replaced in-kind, to include but not limited to expansion joints, control joints, etc., and sealed with approved joint sealing material.</p> <p>Broken concrete shall be removed and hauled to an area identified by project inspector at no direct pay.</p>			170	Square Yard

All Work Shall Conform to Louisiana Standard Specifications for Roads and Bridges, Latest Edition

Panels will be marked in the field once project is ready to begin.

Item	Description	Length	Width	Quantity	Unit
706-03-00500-A	<p>Remove/Replace/Repair Concrete Panels (High Early): All labor, materials, equipment and supervision necessary to, in accordance with these specifications, and LA DOTD Standard Specifications for Roads and Bridges, Section 706 Latest Edition, Remove/Replace/Repair Concrete Pavement. Contractor shall be responsible for removal of concrete and all base materials to a depth of 8" below the bottom grade of the new 8" thick concrete panel. Replacement base material shall be River Sand or Pumped Sand. Base repair and/or patch is not limited to a square yardage quantity, but may include the entire panel if directed by Department of Public Works inspection staff. This item is at no direct pay. Prior to contractor pouring replacement concrete panel and rollover curb, base material shall be examined by project inspector. Contractor shall inspect the project site and bid accordingly. Panels identified for removal and replacement next to and/or adjacent to new panels shall be saw-cut along the adjoining edge. Any damage caused by contractor operations shall be repaired immediately at no direct pay.</p> <p>Replacement panels shall be Fiber reinforced, 4000 psi @ 72 Hours, 8" thick concrete, with 3/4" smooth dowel bars into existing concrete pavement @ 18" on-center for butt/construction joints. Use #4 deformed bar for longitudinal joints 2' on center. Panels longer than 15' in length shall be split into two panels by means of keyway and load transfer bars.</p> <p>Joints shall be replaced in-kind, to include but not limited to expansion joints, control joints, etc., and sealed with approved joint sealing material.</p> <p>Broken concrete shall be removed and hauled to an area identified by project inspector at no direct pay.</p>			90	Square Yard

All Work Shall Conform to Louisiana Standard Specifications for Roads and Bridges, Latest Edition

Panels will be marked in the field once project is ready to begin.

Item	Description	Length	Width	Quantity	Unit
	<p>General Notes:</p> <ol style="list-style-type: none"> 1. Contractor shall field verify all quantities and measurements. 2. Contractor shall be responsible for locating and protecting all existing utilities. 3. Two-way traffic shall be maintained at all times during construction. Contractor shall have flagmen on both ends of work zone. If Police details are used for traffic control this does not take the place of flag men. 4. Construction work shall not begin until signs, barricades, project signs and other traffic devices have been erected and approved. Contractor shall maintain project and construction signs. 5. All existing sewer lines shall be tied-in at no direct pay. 6. Asphalt and concrete driveway tie-ins shall be tied in to existing surface material. 7. Any additional work performed by the contractor without prior written approval from St Tammany Parish Department of Engineering, the cost of the work will be borne by the contractor and will not be reimbursed by the Parish. 8. Contractor shall ensure roadway and shoulders drain accordingly without any surface ponding/"bird baths" after rain events. 9. Materials Testing: All required testing and reporting shall be the contractor's responsibility at no direct pay. Sampling and Testing will be performed in accordance with the St. Tammany Parish Roadway Testing and Inspection Standards for Residential Subdivisions (Attached with Bid Proposal) and LADOTD Standard Specifications for Roads and Bridges, Latest Edition, Section 101 and 106. 10. Roads and surrounding areas shall be dressed after 7 calendar days and no later than 10 calendar days after opening of street. Late Fee of \$1.00 per Linear Foot per Calendar Day shall be charged if not completed with the specified time frame. 11. If any driveways are impacted, contractor shall give resident 24 hour notice that they need to move vehicles so as to not get blocked in and that they will not be able to access the driveway for three days after pouring concrete. 				
	<p>Project Summary: Contractor shall provide all labor, materials, equipment and supervision necessary to Remove, Replace and/or Repair Concrete Panels and Concrete Rollover/Barrier Curbs.</p>				
727-01	<p>Mobilization: All labor and materials necessary to accomplish preparatory work and operations, including those necessary for movement of personnel, equipment, supplies and incidentals to the project site.</p>			1	Lump Sum

All Work Shall Conform to Louisiana Standard Specifications for Roads and Bridges, Latest Edition

Panels will be marked in the field once project is ready to begin.

Item	Description	Length	Width	Quantity	Unit
713-01	Temporary Signs and Barricades: All labor, materials, equipment and supervision necessary to furnish, install, maintain and remove temporary construction barricades, precast concrete barriers, lights, signals, pavement markings and signs, including project signs ; providing flaggers; and complying with all other requirements regarding the protection of the work, workers and safety of the public. Unless otherwise noted in the plans or special provisions this work also includes traffic control management in compliance with contract documents and the Manual on Uniform Traffic Control Devices (MUTCD), including the installation, inspection, maintenance, and removal of all traffic control devices on the project. This item shall not be construed to relieve the contractor of responsibilities for the safety of the public, for liability in connection therewith, or compliance with State and local laws or ordinances. Signs, barricades, barriers, channelizing devices, pavement markings, etc., shall comply with plan details, the MUTCD and Section 713 of LADOTD Standard Specifications for Roads and Bridges, Latest Edition. Construction work shall not begin until signs, barricades, project signs and other traffic devices have been erected and approved.			1	Lump Sum
S-00001	Sawcutting (Concrete): All Labor, Materials, equipment, and supervision necessary to cut full depth concrete road panels. This item is separate and apart from cutting the joints of the road to prevent damaging another panel that is scheduled to remain.			100	IN/FT
715-01-00100	Topsoil Shoulder Material: LA DOTD Standard Specification for Roads and Bridges, Section 401. All labor, materials and equipment necessary to furnish and place Topsoil for shoulder material (Adjusted Vehicular Measurement). Contractor shall place specified shoulder material flush with the asphalt wearing surface course to a maximum of 12" wide. This material shall be graded uniformly throughout the project. Should any excess incidental construction material extend beyond the 12" maximum limit, the material shall be removed and properly disposed of off-site. The finished specified shoulder material shall not consist of any foreign material that is not contained with the parent material.			1	Cubic Yard

All Work Shall Conform to Louisiana Standard Specifications for Roads and Bridges, Latest Edition

Panels will be marked in the field once project is ready to begin.

Item	Description	Length	Width	Quantity	Unit
<p>706-03-00500</p>	<p>Remove/Replace/Repair Concrete Panels: All labor, materials, equipment and supervision necessary to, in accordance with these specifications, and LA DOTD Standard Specifications for Roads and Bridges, Section 706 Latest Edition, Remove/Replace/Repair Concrete Pavement. Contractor shall be responsible for removal of concrete, curbing, and all base materials to a depth of 8" below the bottom grade of the new 8" thick concrete panel. Replacement base material shall be River Sand or Pumped Sand. Base repair and/or patch is not limited to a square yardage quantity, but may include the entire panel if directed by Department of Public Works inspection staff. This item is at no direct pay. Prior to contractor pouring replacement concrete panel and rollover curb, base material shall be examined by project inspector. Contractor shall inspect the project site and bid accordingly. Panels identified for removal and replacement next to and/or adjacent to new panels shall be saw-cut along the adjoining edge. Any damage caused by contractor operations shall be repaired immediately at no direct pay.</p> <p>Replacement panels shall be Fiber reinforced, 4000 psi, 8" thick concrete, with 3/4" smooth dowel bars into existing concrete pavement @ 18" on-center for butt/construction joints. Use #4 deformed bar for longitudinal joints 2' on center. Panels longer than 15' in length shall be split into two panels by means of keyway and load transfer bars.</p> <p>Joints shall be replaced in-kind, to include but not limited to expansion joints, control joints, etc., and sealed with approved joint sealing material.</p> <p>Broken concrete shall be removed and hauled to an area identified by project inspector at no direct pay.</p>			<p>145</p>	<p>Square Yard</p>

All Work Shall Conform to Louisiana Standard Specifications for Roads and Bridges, Latest Edition

Panels will be marked in the field once project is ready to begin.

Item	Description	Length	Width	Quantity	Unit
	<p>General Notes:</p> <ol style="list-style-type: none"> 1. Contractor shall field verify all quantities and measurements. 2. Contractor shall be responsible for locating and protecting all existing utilities. 3. Two-way traffic shall be maintained at all times during construction. Contractor shall have flagmen on both ends of work zone. If Police details are used for traffic control this does not take the place of flag men. 4. Construction work shall not begin until signs, barricades, project signs and other traffic devices have been erected and approved. Contractor shall maintain project and construction signs. 5. All existing sewer lines shall be tied-in at no direct pay. 6. Asphalt and concrete driveway tie-ins shall be tied in to existing surface material. 7. Any additional work performed by the contractor without prior written approval from St Tammany Parish Department of Engineering, the cost of the work will be borne by the contractor and will not be reimbursed by the Parish. 8. Contractor shall ensure roadway and shoulders drain accordingly without any surface ponding/"bird baths" after rain events. 9. Materials Testing: All required testing and reporting shall be the contractor's responsibility at no direct pay. Sampling and Testing will be performed in accordance with the St. Tammany Parish Roadway Testing and Inspection Standards for Residential Subdivisions (Attached with Bid Proposal) and LADOTD Standard Specifications for Roads and Bridges, Latest Edition, Section 101 and 106. 10. Roads and surrounding areas shall be dressed after 7 calendar days and no later than 10 calendar days after opening of street. Late Fee of \$1.00 per Linear Foot per Calendar Day shall be charged if not completed with the specified time frame. 11. If any driveways are impacted, contractor shall give resident 24 hour notice that they need to move vehicles so as to not get blocked in and that they will not be able to access the driveway for three days after pouring concrete. 				
	<p>Project Summary: Contractor shall provide all labor, materials, equipment and supervision necessary to Remove, Replace and/or Repair Concrete Panels and Concrete Rollover/Barrier Curbs.</p>				
727-01	<p>Mobilization: All labor and materials necessary to accomplish preparatory work and operations, including those necessary for movement of personnel, equipment, supplies and incidentals to the project site.</p>			1	Lump Sum

All Work Shall Conform to Louisiana Standard Specifications for Roads and Bridges, Latest Edition

Panels will be marked in the field once project is ready to begin.

Item	Description	Length	Width	Quantity	Unit
713-01	<p>Temporary Signs and Barricades: All labor, materials, equipment and supervision necessary to furnish, install, maintain and remove temporary construction barricades, precast concrete barriers, lights, signals, pavement markings and signs, including project signs; providing flaggers; and complying with all other requirements regarding the protection of the work, workers and safety of the public. Unless otherwise noted in the plans or special provisions this work also includes traffic control management in compliance with contract documents and the Manual on Uniform Traffic Control Devices (MUTCD), including the installation, inspection, maintenance, and removal of all traffic control devices on the project. This item shall not be construed to relieve the contractor of responsibilities for the safety of the public, for liability in connection therewith, or compliance with State and local laws or ordinances. Signs, barricades, barriers, channelizing devices, pavement markings, etc., shall comply with plan details, the MUTCD and Section 713 of LADOTD Standard Specifications for Roads and Bridges, Latest Edition. Construction work shall not begin until signs, barricades, project signs and other traffic devices have been erected and approved.</p>			1	Lump Sum
S-00001	<p>Sawcutting (Concrete): All Labor, Materials, equipment, and supervision necessary to cut full depth concrete road panels. This item is separate and apart from cutting the joints of the road to prevent damaging another panel that is scheduled to remain.</p>			100	IN/FT
715-01-00100	<p>Topsoil Shoulder Material: LA DOTD Standard Specification for Roads and Bridges, Section 401. All labor, materials and equipment necessary to furnish and place Topsoil for shoulder material (Adjusted Vehicular Measurement). Contractor shall place specified shoulder material flush with the asphalt wearing surface course to a maximum of 12" wide. This material shall be graded uniformly throughout the project. Should any excess incidental construction material extend beyond the 12" maximum limit, the material shall be removed and properly disposed of off-site. The finished specified shoulder material shall not consist of any foreign material that is not contained with the parent material.</p>			2	Cubic Yard

All Work Shall Conform to Louisiana Standard Specifications for Roads and Bridges, Latest Edition

Panels will be marked in the field once project is ready to begin.

Item	Description	Length	Width	Quantity	Unit
<p>706-03-00500</p>	<p>Remove/Replace/Repair Concrete Panels: All labor, materials, equipment and supervision necessary to, in accordance with these specifications, and LA DOTD Standard Specifications for Roads and Bridges, Section 706 Latest Edition, Remove/Replace/Repair Concrete Pavement. Contractor shall be responsible for removal of concrete, curbing, and all base materials to a depth of 8" below the bottom grade of the new 8" thick concrete panel. Replacement base material shall be River Sand or Pumped Sand. Base repair and/or patch is not limited to a square yardage quantity, but may include the entire panel if directed by Department of Public Works inspection staff. This item is at no direct pay. Prior to contractor pouring replacement concrete panel and rollover curb, base material shall be examined by project inspector. Contractor shall inspect the project site and bid accordingly. Panels identified for removal and replacement next to and/or adjacent to new panels shall be saw-cut along the adjoining edge. Any damage caused by contractor operations shall be repaired immediately at no direct pay.</p> <p>Replacement panels shall be Fiber reinforced, 4000 psi, 8" thick concrete, with 3/4" smooth dowel bars into existing concrete pavement @ 18" on-center for butt/construction joints. Use #4 deformed bar for longitudinal joints 2' on center. Panels longer than 15' in length shall be split into two panels by means of keyway and load transfer bars.</p> <p>Joints shall be replaced in-kind, to include but not limited to expansion joints, control joints, etc., and sealed with approved joint sealing material.</p> <p>Broken concrete shall be removed and hauled to an area identified by project inspector at no direct pay.</p>			<p>130</p>	<p>Square Yard</p>

All Work Shall Conform to Louisiana Standard Specifications for Roads and Bridges, Latest Edition

Panels will be marked in the field once project is ready to begin.

Item	Description	Length	Width	Quantity	Unit
<p>706-03-00500-A</p>	<p>Remove/Replace/Repair Concrete Panels (High Early): All labor, materials, equipment and supervision necessary to, in accordance with these specifications, and LA DOTD Standard Specifications for Roads and Bridges, Section 706 Latest Edition, Remove/Replace/Repair Concrete Pavement. Contractor shall be responsible for removal of concrete and all base materials to a depth of 8" below the bottom grade of the new 8" thick concrete panel. Replacement base material shall be River Sand or Pumped Sand. Base repair and/or patch is not limited to a square yardage quantity, but may include the entire panel if directed by Department of Public Works inspection staff. This item is at no direct pay. Prior to contractor pouring replacement concrete panel and rollover curb, base material shall be examined by project inspector. Contractor shall inspect the project site and bid accordingly. Panels identified for removal and replacement next to and/or adjacent to new panels shall be saw-cut along the adjoining edge. Any damage caused by contractor operations shall be repaired immediately at no direct pay.</p> <p>Replacement panels shall be Fiber reinforced, 4000 psi @ 72 Hours, 8" thick concrete, with 3/4" smooth dowel bars into existing concrete pavement @ 18" on-center for butt/construction joints. Use #4 deformed bar for longitudinal joints 2' on center. Panels longer than 15' in length shall be split into two panels by means of keyway and load transfer bars.</p> <p>Joints shall be replaced in-kind, to include but not limited to expansion joints, control joints, etc., and sealed with approved joint sealing material.</p> <p>Broken concrete shall be removed and hauled to an area identified by project inspector at no direct pay.</p>			<p>50</p>	<p>Square Yard</p>

All Work Shall Conform to Louisiana Standard Specifications for Roads and Bridges, Latest Edition

Panels will be marked in the field once project is ready to begin.

Item	Description	Length	Width	Quantity	Unit
	<p>General Notes:</p> <ol style="list-style-type: none"> 1. Contractor shall field verify all quantities and measurements. 2. Contractor shall be responsible for locating and protecting all existing utilities. 3. Two-way traffic shall be maintained at all times during construction. Contractor shall have flagmen on both ends of work zone. If Police details are used for traffic control this does not take the place of flag men. 4. Construction work shall not begin until signs, barricades, project signs and other traffic devices have been erected and approved. Contractor shall maintain project and construction signs. 5. All existing sewer lines shall be tied-in at no direct pay. 6. Asphalt and concrete driveway tie-ins shall be tied in to existing surface material. 7. Any additional work performed by the contractor without prior written approval from St Tammany Parish Department of Engineering, the cost of the work will be borne by the contractor and will not be reimbursed by the Parish. 8. Contractor shall ensure roadway and shoulders drain accordingly without any surface ponding/"bird baths" after rain events. 9. Materials Testing: All required testing and reporting shall be the contractor's responsibility at no direct pay. Sampling and Testing will be performed in accordance with the St. Tammany Parish Roadway Testing and Inspection Standards for Residential Subdivisions (Attached with Bid Proposal) and LADOTD Standard Specifications for Roads and Bridges, Latest Edition, Section 101 and 106. 10. Roads and surrounding areas shall be dressed after 7 calendar days and no later than 10 calendar days after opening of street. Late Fee of \$1.00 per Linear Foot per Calendar Day shall be charged if not completed with the specified time frame. 11. If any driveways are impacted, contractor shall give resident 24 hour notice that they need to move vehicles so as to not get blocked in and that they will not be able to access the driveway for three days after pouring concrete. 				
	<p>Project Summary: Contractor shall provide all labor, materials, equipment and supervision necessary to Remove, Replace and/or Repair Concrete Panels and Concrete Rollover/Barrier Curbs.</p>				
727-01	<p>Mobilization: All labor and materials necessary to accomplish preparatory work and operations, including those necessary for movement of personnel, equipment, supplies and incidentals to the project site.</p>			1	Lump Sum

All Work Shall Conform to Louisiana Standard Specifications for Roads and Bridges, Latest Edition

Panels will be marked in the field once project is ready to begin.

Item	Description	Length	Width	Quantity	Unit
713-01	<p>Temporary Signs and Barricades: All labor, materials, equipment and supervision necessary to furnish, install, maintain and remove temporary construction barricades, precast concrete barriers, lights, signals, pavement markings and signs, including project signs; providing flaggers; and complying with all other requirements regarding the protection of the work, workers and safety of the public. Unless otherwise noted in the plans or special provisions this work also includes traffic control management in compliance with contract documents and the Manual on Uniform Traffic Control Devices (MUTCD), including the installation, inspection, maintenance, and removal of all traffic control devices on the project. This item shall not be construed to relieve the contractor of responsibilities for the safety of the public, for liability in connection therewith, or compliance with State and local laws or ordinances. Signs, barricades, barriers, channelizing devices, pavement markings, etc., shall comply with plan details, the MUTCD and Section 713 of LADOTD Standard Specifications for Roads and Bridges, Latest Edition. Construction work shall not begin until signs, barricades, project signs and other traffic devices have been erected and approved.</p>			1	Lump Sum
S-00001	<p>Sawcutting (Concrete): All Labor, Materials, equipment, and supervision necessary to cut full depth concrete road panels. This item is separate and apart from cutting the joints of the road to prevent damaging another panel that is scheduled to remain.</p>			100	IN/FT
715-01-00100	<p>Topsoil Shoulder Material: LA DOTD Standard Specification for Roads and Bridges, Section 401. All labor, materials and equipment necessary to furnish and place Topsoil for shoulder material (Adjusted Vehicular Measurement). Contractor shall place specified shoulder material flush with the asphalt wearing surface course to a maximum of 12" wide. This material shall be graded uniformly throughout the project. Should any excess incidental construction material extend beyond the 12" maximum limit, the material shall be removed and properly disposed of off-site. The finished specified shoulder material shall not consist of any foreign material that is not contained with the parent material.</p>			1	Cubic Yard

All Work Shall Conform to Louisiana Standard Specifications for Roads and Bridges, Latest Edition

Panels will be marked in the field once project is ready to begin.

Item	Description	Length	Width	Quantity	Unit
706-03-00500	<p>Remove/Replace/Repair Concrete Panels: All labor, materials, equipment and supervision necessary to, in accordance with these specifications, and LA DOTD Standard Specifications for Roads and Bridges, Section 706 Latest Edition, Remove/Replace/Repair Concrete Pavement. Contractor shall be responsible for removal of concrete, curbing, and all base materials to a depth of 8" below the bottom grade of the new 8" thick concrete panel. Replacement base material shall be River Sand or Pumped Sand. Base repair and/or patch is not limited to a square yardage quantity, but may include the entire panel if directed by Department of Public Works inspection staff. This item is at no direct pay. Prior to contractor pouring replacement concrete panel and rollover curb, base material shall be examined by project inspector. Contractor shall inspect the project site and bid accordingly. Panels identified for removal and replacement next to and/or adjacent to new panels shall be saw-cut along the adjoining edge. Any damage caused by contractor operations shall be repaired immediately at no direct pay.</p> <p>Replacement panels shall be Fiber reinforced, 4000 psi, 8" thick concrete, with 3/4" smooth dowel bars into existing concrete pavement @ 18" on-center for butt/construction joints. Use #4 deformed bar for longitudinal joints 2' on center. Panels longer than 15' in length shall be split into two panels by means of keyway and load transfer bars.</p> <p>Joints shall be replaced in-kind, to include but not limited to expansion joints, control joints, etc., and sealed with approved joint sealing material.</p> <p>Broken concrete shall be removed and hauled to an area identified by project inspector at no direct pay.</p>			118	Square Yard

All Work Shall Conform to Louisiana Standard Specifications for Roads and Bridges, Latest Edition

Panels will be marked in the field once project is ready to begin.

Item	Description	Length	Width	Quantity	Unit
<p>706-03-00500-A</p>	<p>Remove/Replace/Repair Concrete Panels (High Early): All labor, materials, equipment and supervision necessary to, in accordance with these specifications, and LA DOTD Standard Specifications for Roads and Bridges, Section 706 Latest Edition, Remove/Replace/Repair Concrete Pavement. Contractor shall be responsible for removal of concrete, curbing, and all base materials to a depth of 8" below the bottom grade of the new 8" thick concrete panel. Replacement base material shall be River Sand or Pumped Sand. Base repair and/or patch is not limited to a square yardage quantity, but may include the entire panel if directed by Department of Public Works inspection staff. This item is at no direct pay. Prior to contractor pouring replacement concrete panel and rollover curb, base material shall be examined by project inspector. Contractor shall inspect the project site and bid accordingly. Panels identified for removal and replacement next to and/or adjacent to new panels shall be saw-cut along the adjoining edge. Any damage caused by contractor operations shall be repaired immediately at no direct pay.</p> <p>Replacement panels shall be Fiber reinforced, 4000 psi @ 72 Hours, 8" thick concrete, with 3/4" smooth dowel bars into existing concrete pavement @ 18" on-center for butt/construction joints. Use #4 deformed bar for longitudinal joints 2' on center. Panels longer than 15' in length shall be split into two panels by means of keyway and load transfer bars.</p> <p>Joints shall be replaced in-kind, to include but not limited to expansion joints, control joints, etc., and sealed with approved joint sealing material.</p> <p>Broken concrete shall be removed and hauled to an area identified by project inspector at no direct pay.</p>			<p>40</p>	<p>Square Yard</p>

All Work Shall Conform to Louisiana Standard Specifications for Roads and Bridges, Latest Edition

Panels will be marked in the field once project is ready to begin.

Item	Description	Length	Width	Quantity	Unit
	<p>General Notes:</p> <ol style="list-style-type: none"> 1. Contractor shall field verify all quantities and measurements. 2. Contractor shall be responsible for locating and protecting all existing utilities. 3. Two-way traffic shall be maintained at all times during construction. Contractor shall have flagmen on both ends of work zone. If Police details are used for traffic control this does not take the place of flag men. 4. Construction work shall not begin until signs, barricades, project signs and other traffic devices have been erected and approved. Contractor shall maintain project and construction signs. 5. All existing sewer lines shall be tied-in at no direct pay. 6. Asphalt and concrete driveway tie-ins shall be tied in to existing surface material. 7. Any additional work performed by the contractor without prior written approval from St Tammany Parish Department of Engineering, the cost of the work will be borne by the contractor and will not be reimbursed by the Parish. 8. Contractor shall ensure roadway and shoulders drain accordingly without any surface ponding/"bird baths" after rain events. 9. Materials Testing: All required testing and reporting shall be the contractor's responsibility at no direct pay. Sampling and Testing will be performed in accordance with the St. Tammany Parish Roadway Testing and Inspection Standards for Residential Subdivisions (Attached with Bid Proposal) and LADOTD Standard Specifications for Roads and Bridges, Latest Edition, Section 101 and 106. 10. Roads and surrounding areas shall be dressed after 7 calendar days and no later than 10 calendar days after opening of street. Late Fee of \$1.00 per Linear Foot per Calendar Day shall be charged if not completed with the specified time frame. 11. If any driveways are impacted, contractor shall give resident 24 hour notice that they need to move vehicles so as to not get blocked in and that they will not be able to access the driveway for three days after pouring concrete. 				
	<p>Project Summary: Contractor shall provide all labor, materials, equipment and supervision necessary to Remove, Replace and/or Repair Concrete Panels and Concrete Rollover/Barrier Curbs.</p>				
727-01	<p>Mobilization: All labor and materials necessary to accomplish preparatory work and operations, including those necessary for movement of personnel, equipment, supplies and incidentals to the project site.</p>			1	Lump Sum

All Work Shall Conform to Louisiana Standard Specifications for Roads and Bridges, Latest Edition

Panels will be marked in the field once project is ready to begin.

Item	Description	Length	Width	Quantity	Unit
713-01	<p>Temporary Signs and Barricades: All labor, materials, equipment and supervision necessary to furnish, install, maintain and remove temporary construction barricades, precast concrete barriers, lights, signals, pavement markings and signs, including project signs; providing flaggers; and complying with all other requirements regarding the protection of the work, workers and safety of the public. Unless otherwise noted in the plans or special provisions this work also includes traffic control management in compliance with contract documents and the Manual on Uniform Traffic Control Devices (MUTCD), including the installation, inspection, maintenance, and removal of all traffic control devices on the project. This item shall not be construed to relieve the contractor of responsibilities for the safety of the public, for liability in connection therewith, or compliance with State and local laws or ordinances. Signs, barricades, barriers, channelizing devices, pavement markings, etc., shall comply with plan details, the MUTCD and Section 713 of LADOTD Standard Specifications for Roads and Bridges, Latest Edition. Construction work shall not begin until signs, barricades, project signs and other traffic devices have been erected and approved.</p>			1	Lump Sum
S-00001	<p>Sawcutting (Concrete): All Labor, Materials, equipment, and supervision necessary to cut full depth concrete road panels. This item is separate and apart from cutting the joints of the road to prevent damaging another panel that is scheduled to remain.</p>			60	IN/FT
715-01-00100	<p>Topsoil Shoulder Material: LA DOTD Standard Specification for Roads and Bridges, Section 401. All labor, materials and equipment necessary to furnish and place Topsoil for shoulder material (Adjusted Vehicular Measurement). Contractor shall place specified shoulder material flush with the asphalt wearing surface course to a maximum of 12" wide. This material shall be graded uniformly throughout the project. Should any excess incidental construction material extend beyond the 12" maximum limit, the material shall be removed and properly disposed of off-site. The finished specified shoulder material shall not consist of any foreign material that is not contained with the parent material.</p>			1	Cubic Yard

All Work Shall Conform to Louisiana Standard Specifications for Roads and Bridges, Latest Edition

Panels will be marked in the field once project is ready to begin.

Item	Description	Length	Width	Quantity	Unit
<p>706-03-00500</p>	<p>Remove/Replace/Repair Concrete Panels: All labor, materials, equipment and supervision necessary to, in accordance with these specifications, and LA DOTD Standard Specifications for Roads and Bridges, Section 706 Latest Edition, Remove/Replace/Repair Concrete Pavement. Contractor shall be responsible for removal of concrete, curbing, and all base materials to a depth of 8" below the bottom grade of the new 8" thick concrete panel. Replacement base material shall be River Sand or Pumped Sand. Base repair and/or patch is not limited to a square yardage quantity, but may include the entire panel if directed by Department of Public Works inspection staff. This item is at no direct pay. Prior to contractor pouring replacement concrete panel and rollover curb, base material shall be examined by project inspector. Contractor shall inspect the project site and bid accordingly. Panels identified for removal and replacement next to and/or adjacent to new panels shall be saw-cut along the adjoining edge. Any damage caused by contractor operations shall be repaired immediately at no direct pay.</p> <p>Replacement panels shall be Fiber reinforced, 4000 psi, 8" thick concrete, with 3/4" smooth dowel bars into existing concrete pavement @ 18" on-center for butt/construction joints. Use #4 deformed bar for longitudinal joints 2' on center. Panels longer than 15' in length shall be split into two panels by means of keyway and load transfer bars.</p> <p>Joints shall be replaced in-kind, to include but not limited to expansion joints, control joints, etc., and sealed with approved joint sealing material.</p> <p>Broken concrete shall be removed and hauled to an area identified by project inspector at no direct pay.</p>			<p>240</p>	<p>Square Yard</p>

All Work Shall Conform to Louisiana Standard Specifications for Roads and Bridges, Latest Edition

Panels will be marked in the field once project is ready to begin.

Item	Description	Length	Width	Quantity	Unit
<p>706-03-00500-A</p>	<p>Remove/Replace/Repair Concrete Panels (High Early): All labor, materials, equipment and supervision necessary to, in accordance with these specifications, and LA DOTD Standard Specifications for Roads and Bridges, Section 706 Latest Edition, Remove/Replace/Repair Concrete Pavement. Contractor shall be responsible for removal of concrete, curbing, and all base materials to a depth of 8" below the bottom grade of the new 8" thick concrete panel. Replacement base material shall be River Sand or Pumped Sand. Base repair and/or patch is not limited to a square yardage quantity, but may include the entire panel if directed by Department of Public Works inspection staff. This item is at no direct pay. Prior to contractor pouring replacement concrete panel and rollover curb, base material shall be examined by project inspector. Contractor shall inspect the project site and bid accordingly. Panels identified for removal and replacement next to and/or adjacent to new panels shall be saw-cut along the adjoining edge. Any damage caused by contractor operations shall be repaired immediately at no direct pay.</p> <p>Replacement panels shall be Fiber reinforced, 4000 psi @ 72 Hours, 8" thick concrete, with 3/4" smooth dowel bars into existing concrete pavement @ 18" on-center for butt/construction joints. Use #4 deformed bar for longitudinal joints 2' on center. Panels longer than 15' in length shall be split into two panels by means of keyway and load transfer bars.</p> <p>Joints shall be replaced in-kind, to include but not limited to expansion joints, control joints, etc., and sealed with approved joint sealing material.</p> <p>Broken concrete shall be removed and hauled to an area identified by project inspector at no direct pay.</p>			<p>100</p>	<p>Square Yard</p>

All Work Shall Conform to Louisiana Standard Specifications for Roads and Bridges, Latest Edition

Panels will be marked in the field once project is ready to begin.

Item	Description	Length	Width	Quantity	Unit
	<p>General Notes:</p> <ol style="list-style-type: none"> 1. Contractor shall field verify all quantities and measurements. 2. Contractor shall be responsible for locating and protecting all existing utilities. 3. Two-way traffic shall be maintained at all times during construction. Contractor shall have flagmen on both ends of work zone. If Police details are used for traffic control this does not take the place of flag men. 4. Construction work shall not begin until signs, barricades, project signs and other traffic devices have been erected and approved. Contractor shall maintain project and construction signs. 5. All existing sewer lines shall be tied-in at no direct pay. 6. Asphalt and concrete driveway tie-ins shall be tied in to existing surface material. 7. Any additional work performed by the contractor without prior written approval from St Tammany Parish Department of Engineering, the cost of the work will be borne by the contractor and will not be reimbursed by the Parish. 8. Contractor shall ensure roadway and shoulders drain accordingly without any surface ponding/"bird baths" after rain events. 9. Materials Testing: All required testing and reporting shall be the contractor's responsibility at no direct pay. Sampling and Testing will be performed in accordance with the St. Tammany Parish Roadway Testing and Inspection Standards for Residential Subdivisions (Attached with Bid Proposal) and LADOTD Standard Specifications for Roads and Bridges, Latest Edition, Section 101 and 106. 10. Roads and surrounding areas shall be dressed after 7 calendar days and no later than 10 calendar days after opening of street. Late Fee of \$1.00 per Linear Foot per Calendar Day shall be charged if not completed with the specified time frame. 11. If any driveways are impacted, contractor shall give resident 24 hour notice that they need to move vehicles so as to not get blocked in and that they will not be able to access the driveway for three days after pouring concrete. 				
	<p>Project Summary: Contractor shall provide all labor, materials, equipment and supervision necessary to Remove, Replace and/or Repair Concrete Panels and Concrete Rollover/Barrier Curbs.</p>				
727-01	<p>Mobilization: All labor and materials necessary to accomplish preparatory work and operations, including those necessary for movement of personnel, equipment, supplies and incidentals to the project site.</p>			1	Lump Sum

All Work Shall Conform to Louisiana Standard Specifications for Roads and Bridges, Latest Edition

Panels will be marked in the field once project is ready to begin.

Item	Description	Length	Width	Quantity	Unit
713-01	<p>Temporary Signs and Barricades: All labor, materials, equipment and supervision necessary to furnish, install, maintain and remove temporary construction barricades, precast concrete barriers, lights, signals, pavement markings and signs, including project signs; providing flaggers; and complying with all other requirements regarding the protection of the work, workers and safety of the public. Unless otherwise noted in the plans or special provisions this work also includes traffic control management in compliance with contract documents and the Manual on Uniform Traffic Control Devices (MUTCD), including the installation, inspection, maintenance, and removal of all traffic control devices on the project. This item shall not be construed to relieve the contractor of responsibilities for the safety of the public, for liability in connection therewith, or compliance with State and local laws or ordinances. Signs, barricades, barriers, channelizing devices, pavement markings, etc., shall comply with plan details, the MUTCD and Section 713 of LADOTD Standard Specifications for Roads and Bridges, Latest Edition. Construction work shall not begin until signs, barricades, project signs and other traffic devices have been erected and approved.</p>			1	Lump Sum
S-00001	<p>Sawcutting (Concrete): All Labor, Materials, equipment, and supervision necessary to cut full depth concrete road panels. This item is separate and apart from cutting the joints of the road to prevent damaging another panel that is scheduled to remain.</p>			100	IN/FT
715-01-00100	<p>Topsoil Shoulder Material: LA DOTD Standard Specification for Roads and Bridges, Section 401. All labor, materials and equipment necessary to furnish and place Topsoil for shoulder material (Adjusted Vehicular Measurement). Contractor shall place specified shoulder material flush with the asphalt wearing surface course to a maximum of 12" wide. This material shall be graded uniformly throughout the project. Should any excess incidental construction material extend beyond the 12" maximum limit, the material shall be removed and properly disposed of off-site. The finished specified shoulder material shall not consist of any foreign material that is not contained with the parent material.</p>			1	Cubic Yard

All Work Shall Conform to Louisiana Standard Specifications for Roads and Bridges, Latest Edition

Panels will be marked in the field once project is ready to begin.

Item	Description	Length	Width	Quantity	Unit
706-03-00500	<p>Remove/Replace/Repair Concrete Panels: All labor, materials, equipment and supervision necessary to, in accordance with these specifications, and LA DOTD Standard Specifications for Roads and Bridges, Section 706 Latest Edition, Remove/Replace/Repair Concrete Pavement. Contractor shall be responsible for removal of concrete, curbing, and all base materials to a depth of 8" below the bottom grade of the new 8" thick concrete panel. Replacement base material shall be River Sand or Pumped Sand. Base repair and/or patch is not limited to a square yardage quantity, but may include the entire panel if directed by Department of Public Works inspection staff. This item is at no direct pay. Prior to contractor pouring replacement concrete panel and rollover curb, base material shall be examined by project inspector. Contractor shall inspect the project site and bid accordingly. Panels identified for removal and replacement next to and/or adjacent to new panels shall be saw-cut along the adjoining edge. Any damage caused by contractor operations shall be repaired immediately at no direct pay.</p> <p>Replacement panels shall be Fiber reinforced, 4000 psi, 8" thick concrete, with 3/4" smooth dowel bars into existing concrete pavement @ 18" on-center for butt/construction joints. Use #4 deformed bar for longitudinal joints 2' on center. Panels longer than 15' in length shall be split into two panels by means of keyway and load transfer bars.</p> <p>Joints shall be replaced in-kind, to include but not limited to expansion joints, control joints, etc., and sealed with approved joint sealing material.</p> <p>Broken concrete shall be removed and hauled to an area identified by project inspector at no direct pay.</p>			118	Square Yard

All Work Shall Conform to Louisiana Standard Specifications for Roads and Bridges, Latest Edition

Panels will be marked in the field once project is ready to begin.

Item	Description	Length	Width	Quantity	Unit
<p>706-03-00500-A</p>	<p>Remove/Replace/Repair Concrete Panels (High Early): All labor, materials, equipment and supervision necessary to, in accordance with these specifications, and LA DOTD Standard Specifications for Roads and Bridges, Section 706 Latest Edition, Remove/Replace/Repair Concrete Pavement. Contractor shall be responsible for removal of concrete, curbing, and all base materials to a depth of 8" below the bottom grade of the new 8" thick concrete panel. Replacement base material shall be River Sand or Pumped Sand. Base repair and/or patch is not limited to a square yardage quantity, but may include the entire panel if directed by Department of Public Works inspection staff. This item is at no direct pay. Prior to contractor pouring replacement concrete panel and rollover curb, base material shall be examined by project inspector. Contractor shall inspect the project site and bid accordingly. Panels identified for removal and replacement next to and/or adjacent to new panels shall be saw-cut along the adjoining edge. Any damage caused by contractor operations shall be repaired immediately at no direct pay.</p> <p>Replacement panels shall be Fiber reinforced, 4000 psi @ 72 Hours, 8" thick concrete, with 3/4" smooth dowel bars into existing concrete pavement @ 18" on-center for butt/construction joints. Use #4 deformed bar for longitudinal joints 2' on center. Panels longer than 15' in length shall be split into two panels by means of keyway and load transfer bars.</p> <p>Joints shall be replaced in-kind, to include but not limited to expansion joints, control joints, etc., and sealed with approved joint sealing material.</p> <p>Broken concrete shall be removed and hauled to an area identified by project inspector at no direct pay.</p>			<p>40</p>	<p>Square Yard</p>

All Work Shall Conform to Louisiana Standard Specifications for Roads and Bridges, Latest Edition

Panels will be marked in the field once project is ready to begin.

Item	Description	Length	Width	Quantity	Unit
	<p>General Notes:</p> <ol style="list-style-type: none"> 1. Contractor shall field verify all quantities and measurements. 2. Contractor shall be responsible for locating and protecting all existing utilities. 3. Two-way traffic shall be maintained at all times during construction. Contractor shall have flagmen on both ends of work zone. If Police details are used for traffic control this does not take the place of flag men. 4. Construction work shall not begin until signs, barricades, project signs and other traffic devices have been erected and approved. Contractor shall maintain project and construction signs. 5. All existing sewer lines shall be tied-in at no direct pay. 6. Asphalt and concrete driveway tie-ins shall be tied in to existing surface material. 7. Any additional work performed by the contractor without prior written approval from St Tammany Parish Department of Engineering, the cost of the work will be borne by the contractor and will not be reimbursed by the Parish. 8. Contractor shall ensure roadway and shoulders drain accordingly without any surface ponding/"bird baths" after rain events. 9. Materials Testing: All required testing and reporting shall be the contractor's responsibility at no direct pay. Sampling and Testing will be performed in accordance with the St. Tammany Parish Roadway Testing and Inspection Standards for Residential Subdivisions (Attached with Bid Proposal) and LADOTD Standard Specifications for Roads and Bridges, Latest Edition, Section 101 and 106. 10. Roads and surrounding areas shall be dressed after 7 calendar days and no later than 10 calendar days after opening of street. Late Fee of \$1.00 per Linear Foot per Calendar Day shall be charged if not completed with the specified time frame. 11. If any driveways are impacted, contractor shall give resident 24 hour notice that they need to move vehicles so as to not get blocked in and that they will not be able to access the driveway for three days after pouring concrete. 				
	<p>Project Summary: Contractor shall provide all labor, materials, equipment and supervision necessary to Remove, Replace and/or Repair Concrete Panels and Concrete Rollover/Barrier Curbs.</p>				
727-01	<p>Mobilization: All labor and materials necessary to accomplish preparatory work and operations, including those necessary for movement of personnel, equipment, supplies and incidentals to the project site.</p>			1	Lump Sum

All Work Shall Conform to Louisiana Standard Specifications for Roads and Bridges, Latest Edition

Panels will be marked in the field once project is ready to begin.

Item	Description	Length	Width	Quantity	Unit
713-01	<p>Temporary Signs and Barricades: All labor, materials, equipment and supervision necessary to furnish, install, maintain and remove temporary construction barricades, precast concrete barriers, lights, signals, pavement markings and signs, including project signs; providing flaggers; and complying with all other requirements regarding the protection of the work, workers and safety of the public. Unless otherwise noted in the plans or special provisions this work also includes traffic control management in compliance with contract documents and the Manual on Uniform Traffic Control Devices (MUTCD), including the installation, inspection, maintenance, and removal of all traffic control devices on the project. This item shall not be construed to relieve the contractor of responsibilities for the safety of the public, for liability in connection therewith, or compliance with State and local laws or ordinances. Signs, barricades, barriers, channelizing devices, pavement markings, etc., shall comply with plan details, the MUTCD and Section 713 of LADOTD Standard Specifications for Roads and Bridges, Latest Edition. Construction work shall not begin until signs, barricades, project signs and other traffic devices have been erected and approved.</p>			1	Lump Sum
S-00001	<p>Sawcutting (Concrete): All Labor, Materials, equipment, and supervision necessary to cut full depth concrete road panels. This item is separate and apart from cutting the joints of the road to prevent damaging another panel that is scheduled to remain.</p>			60	IN/FT
715-01-00100	<p>Topsoil Shoulder Material: LA DOTD Standard Specification for Roads and Bridges, Section 401. All labor, materials and equipment necessary to furnish and place Topsoil for shoulder material (Adjusted Vehicular Measurement). Contractor shall place specified shoulder material flush with the asphalt wearing surface course to a maximum of 12" wide. This material shall be graded uniformly throughout the project. Should any excess incidental construction material extend beyond the 12" maximum limit, the material shall be removed and properly disposed of off-site. The finished specified shoulder material shall not consist of any foreign material that is not contained with the parent material.</p>			2	Cubic Yard

All Work Shall Conform to Louisiana Standard Specifications for Roads and Bridges, Latest Edition

Panels will be marked in the field once project is ready to begin.

Item	Description	Length	Width	Quantity	Unit
706-03-00500	<p>Remove/Replace/Repair Concrete Panels: All labor, materials, equipment and supervision necessary to, in accordance with these specifications, and LA DOTD Standard Specifications for Roads and Bridges, Section 706 Latest Edition, Remove/Replace/Repair Concrete Pavement. Contractor shall be responsible for removal of concrete, curbing, and all base materials to a depth of 8" below the bottom grade of the new 8" thick concrete panel. Replacement base material shall be River Sand or Pumped Sand. Base repair and/or patch is not limited to a square yardage quantity, but may include the entire panel if directed by Department of Public Works inspection staff. This item is at no direct pay. Prior to contractor pouring replacement concrete panel and rollover curb, base material shall be examined by project inspector. Contractor shall inspect the project site and bid accordingly. Panels identified for removal and replacement next to and/or adjacent to new panels shall be saw-cut along the adjoining edge. Any damage caused by contractor operations shall be repaired immediately at no direct pay.</p> <p>Replacement panels shall be Fiber reinforced, 4000 psi, 8" thick concrete, with 3/4" smooth dowel bars into existing concrete pavement @ 18" on-center for butt/construction joints. Use #4 deformed bar for longitudinal joints 2' on center. Panels longer than 15' in length shall be split into two panels by means of keyway and load transfer bars.</p> <p>Joints shall be replaced in-kind, to include but not limited to expansion joints, control joints, etc., and sealed with approved joint sealing material.</p> <p>Broken concrete shall be removed and hauled to an area identified by project inspector at no direct pay.</p>			145	Square Yard

All Work Shall Conform to Louisiana Standard Specifications for Roads and Bridges, Latest Edition

Panels will be marked in the field once project is ready to begin.

Item	Description	Length	Width	Quantity	Unit
<p>706-03-00500-A</p>	<p>Remove/Replace/Repair Concrete Panels (High Early): All labor, materials, equipment and supervision necessary to, in accordance with these specifications, and LA DOTD Standard Specifications for Roads and Bridges, Section 706 Latest Edition, Remove/Replace/Repair Concrete Pavement. Contractor shall be responsible for removal of concrete, curbing, and all base materials to a depth of 8" below the bottom grade of the new 8" thick concrete panel. Replacement base material shall be River Sand or Pumped Sand. Base repair and/or patch is not limited to a square yardage quantity, but may include the entire panel if directed by Department of Public Works inspection staff. This item is at no direct pay. Prior to contractor pouring replacement concrete panel and rollover curb, base material shall be examined by project inspector. Contractor shall inspect the project site and bid accordingly. Panels identified for removal and replacement next to and/or adjacent to new panels shall be saw-cut along the adjoining edge. Any damage caused by contractor operations shall be repaired immediately at no direct pay.</p> <p>Replacement panels shall be Fiber reinforced, 4000 psi @ 72 Hours, 8" thick concrete, with 3/4" smooth dowel bars into existing concrete pavement @ 18" on-center for butt/construction joints. Use #4 deformed bar for longitudinal joints 2' on center. Panels longer than 15' in length shall be split into two panels by means of keyway and load transfer bars.</p> <p>Joints shall be replaced in-kind, to include but not limited to expansion joints, control joints, etc., and sealed with approved joint sealing material.</p> <p>Broken concrete shall be removed and hauled to an area identified by project inspector at no direct pay.</p>			<p>58</p>	<p>Square Yard</p>

All Work Shall Conform to Louisiana Standard Specifications for Roads and Bridges, Latest Edition

Panels will be marked in the field once project is ready to begin.

Item	Description	Length	Width	Quantity	Unit
	<p>General Notes:</p> <ol style="list-style-type: none"> 1. Contractor shall field verify all quantities and measurements. 2. Contractor shall be responsible for locating and protecting all existing utilities. 3. Two-way traffic shall be maintained at all times during construction. Contractor shall have flagmen on both ends of work zone. If Police details are used for traffic control this does not take the place of flag men. 4. Construction work shall not begin until signs, barricades, project signs and other traffic devices have been erected and approved. Contractor shall maintain project and construction signs. 5. All existing sewer lines shall be tied-in at no direct pay. 6. Asphalt and concrete driveway tie-ins shall be tied in to existing surface material. 7. Any additional work performed by the contractor without prior written approval from St Tammany Parish Department of Engineering, the cost of the work will be borne by the contractor and will not be reimbursed by the Parish. 8. Contractor shall ensure roadway and shoulders drain accordingly without any surface ponding/"bird baths" after rain events. 9. Materials Testing: All required testing and reporting shall be the contractor's responsibility at no direct pay. Sampling and Testing will be performed in accordance with the St. Tammany Parish Roadway Testing and Inspection Standards for Residential Subdivisions (Attached with Bid Proposal) and LADOTD Standard Specifications for Roads and Bridges, Latest Edition, Section 101 and 106. 10. Roads and surrounding areas shall be dressed after 7 calendar days and no later than 10 calendar days after opening of street. Late Fee of \$1.00 per Linear Foot per Calendar Day shall be charged if not completed with the specified time frame. 11. If any driveways are impacted, contractor shall give resident 24 hour notice that they need to move vehicles so as to not get blocked in and that they will not be able to access the driveway for three days after pouring concrete. 				
	<p>Project Summary: Contractor shall provide all labor, materials, equipment and supervision necessary to Remove, Replace and/or Repair Concrete Panels and Concrete Rollover/Barrier Curbs.</p>				
727-01	<p>Mobilization: All labor and materials necessary to accomplish preparatory work and operations, including those necessary for movement of personnel, equipment, supplies and incidentals to the project site.</p>			1	Lump Sum

All Work Shall Conform to Louisiana Standard Specifications for Roads and Bridges, Latest Edition

Panels will be marked in the field once project is ready to begin.

Item	Description	Length	Width	Quantity	Unit
713-01	Temporary Signs and Barricades: All labor, materials, equipment and supervision necessary to furnish, install, maintain and remove temporary construction barricades, precast concrete barriers, lights, signals, pavement markings and signs, including project signs ; providing flaggers; and complying with all other requirements regarding the protection of the work, workers and safety of the public. Unless otherwise noted in the plans or special provisions this work also includes traffic control management in compliance with contract documents and the Manual on Uniform Traffic Control Devices (MUTCD), including the installation, inspection, maintenance, and removal of all traffic control devices on the project. This item shall not be construed to relieve the contractor of responsibilities for the safety of the public, for liability in connection therewith, or compliance with State and local laws or ordinances. Signs, barricades, barriers, channelizing devices, pavement markings, etc., shall comply with plan details, the MUTCD and Section 713 of LADOTD Standard Specifications for Roads and Bridges, Latest Edition. Construction work shall not begin until signs, barricades, project signs and other traffic devices have been erected and approved.			1	Lump Sum
S-00001	Sawcutting (Concrete): All Labor, Materials, equipment, and supervision necessary to cut full depth concrete road panels. This item is separate and apart from cutting the joints of the road to prevent damaging another panel that is scheduled to remain.			60	IN/FT
715-01-00100	Topsoil Shoulder Material: LA DOTD Standard Specification for Roads and Bridges, Section 401. All labor, materials and equipment necessary to furnish and place Topsoil for shoulder material (Adjusted Vehicular Measurement). Contractor shall place specified shoulder material flush with the asphalt wearing surface course to a maximum of 12" wide. This material shall be graded uniformly throughout the project. Should any excess incidental construction material extend beyond the 12" maximum limit, the material shall be removed and properly disposed of off-site. The finished specified shoulder material shall not consist of any foreign material that is not contained with the parent material.			2	Cubic Yard

All Work Shall Conform to Louisiana Standard Specifications for Roads and Bridges, Latest Edition

Panels will be marked in the field once project is ready to begin.

Item	Description	Length	Width	Quantity	Unit
706-03-00500	<p>Remove/Replace/Repair Concrete Panels: All labor, materials, equipment and supervision necessary to, in accordance with these specifications, and LA DOTD Standard Specifications for Roads and Bridges, Section 706 Latest Edition, Remove/Replace/Repair Concrete Pavement. Contractor shall be responsible for removal of concrete, curbing, and all base materials to a depth of 8" below the bottom grade of the new 8" thick concrete panel. Replacement base material shall be River Sand or Pumped Sand. Base repair and/or patch is not limited to a square yardage quantity, but may include the entire panel if directed by Department of Public Works inspection staff. This item is at no direct pay. Prior to contractor pouring replacement concrete panel and rollover curb, base material shall be examined by project inspector. Contractor shall inspect the project site and bid accordingly. Panels identified for removal and replacement next to and/or adjacent to new panels shall be saw-cut along the adjoining edge. Any damage caused by contractor operations shall be repaired immediately at no direct pay.</p> <p>Replacement panels shall be Fiber reinforced, 4000 psi, 8" thick concrete, with 3/4" smooth dowel bars into existing concrete pavement @ 18" on-center for butt/construction joints. Use #4 deformed bar for longitudinal joints 2' on center. Panels longer than 15' in length shall be split into two panels by means of keyway and load transfer bars.</p> <p>Joints shall be replaced in-kind, to include but not limited to expansion joints, control joints, etc., and sealed with approved joint sealing material.</p> <p>Broken concrete shall be removed and hauled to an area identified by project inspector at no direct pay.</p>			185	Square Yard

All Work Shall Conform to Louisiana Standard Specifications for Roads and Bridges, Latest Edition

Panels will be marked in the field once project is ready to begin.

Item	Description	Length	Width	Quantity	Unit
<p>706-03-00500-A</p>	<p>Remove/Replace/Repair Concrete Panels (High Early): All labor, materials, equipment and supervision necessary to, in accordance with these specifications, and LA DOTD Standard Specifications for Roads and Bridges, Section 706 Latest Edition, Remove/Replace/Repair Concrete Pavement. Contractor shall be responsible for removal of concrete, curbing, and all base materials to a depth of 8" below the bottom grade of the new 8" thick concrete panel. Replacement base material shall be River Sand or Pumped Sand. Base repair and/or patch is not limited to a square yardage quantity, but may include the entire panel if directed by Department of Public Works inspection staff. This item is at no direct pay. Prior to contractor pouring replacement concrete panel and rollover curb, base material shall be examined by project inspector. Contractor shall inspect the project site and bid accordingly. Panels identified for removal and replacement next to and/or adjacent to new panels shall be saw-cut along the adjoining edge. Any damage caused by contractor operations shall be repaired immediately at no direct pay.</p> <p>Replacement panels shall be Fiber reinforced, 4000 psi @ 72 Hours, 8" thick concrete, with 3/4" smooth dowel bars into existing concrete pavement @ 18" on-center for butt/construction joints. Use #4 deformed bar for longitudinal joints 2' on center. Panels longer than 15' in length shall be split into two panels by means of keyway and load transfer bars.</p> <p>Joints shall be replaced in-kind, to include but not limited to expansion joints, control joints, etc., and sealed with approved joint sealing material.</p> <p>Broken concrete shall be removed and hauled to an area identified by project inspector at no direct pay.</p>			<p>60</p>	<p>Square Yard</p>

All Work Shall Conform to Louisiana Standard Specifications for Roads and Bridges, Latest Edition

Panels will be marked in the field once project is ready to begin.

Item	Description	Length	Width	Quantity	Unit
	<p>General Notes:</p> <ol style="list-style-type: none"> 1. Contractor shall field verify all quantities and measurements. 2. Contractor shall be responsible for locating and protecting all existing utilities. 3. Two-way traffic shall be maintained at all times during construction. Contractor shall have flagmen on both ends of work zone. If Police details are used for traffic control this does not take the place of flag men. 4. Construction work shall not begin until signs, barricades, project signs and other traffic devices have been erected and approved. Contractor shall maintain project and construction signs. 5. All existing sewer lines shall be tied-in at no direct pay. 6. Asphalt and concrete driveway tie-ins shall be tied in to existing surface material. 7. Any additional work performed by the contractor without prior written approval from St Tammany Parish Department of Engineering, the cost of the work will be borne by the contractor and will not be reimbursed by the Parish. 8. Contractor shall ensure roadway and shoulders drain accordingly without any surface ponding/"bird baths" after rain events. 9. Materials Testing: All required testing and reporting shall be the contractor's responsibility at no direct pay. Sampling and Testing will be performed in accordance with the St. Tammany Parish Roadway Testing and Inspection Standards for Residential Subdivisions (Attached with Bid Proposal) and LADOTD Standard Specifications for Roads and Bridges, Latest Edition, Section 101 and 106. 10. Roads and surrounding areas shall be dressed after 7 calendar days and no later than 10 calendar days after opening of street. Late Fee of \$1.00 per Linear Foot per Calendar Day shall be charged if not completed with the specified time frame. 11. If any driveways are impacted, contractor shall give resident 24 hour notice that they need to move vehicles so as to not get blocked in and that they will not be able to access the driveway for three days after pouring concrete. 				
	<p>Project Summary: Contractor shall provide all labor, materials, equipment and supervision necessary to Remove, Replace and/or Repair Concrete Panels and Concrete Rollover/Barrier Curbs.</p>				
727-01	<p>Mobilization: All labor and materials necessary to accomplish preparatory work and operations, including those necessary for movement of personnel, equipment, supplies and incidentals to the project site.</p>			1	Lump Sum

All Work Shall Conform to Louisiana Standard Specifications for Roads and Bridges, Latest Edition

Panels will be marked in the field once project is ready to begin.

Item	Description	Length	Width	Quantity	Unit
713-01	<p>Temporary Signs and Barricades: All labor, materials, equipment and supervision necessary to furnish, install, maintain and remove temporary construction barricades, precast concrete barriers, lights, signals, pavement markings and signs, including project signs; providing flaggers; and complying with all other requirements regarding the protection of the work, workers and safety of the public. Unless otherwise noted in the plans or special provisions this work also includes traffic control management in compliance with contract documents and the Manual on Uniform Traffic Control Devices (MUTCD), including the installation, inspection, maintenance, and removal of all traffic control devices on the project. This item shall not be construed to relieve the contractor of responsibilities for the safety of the public, for liability in connection therewith, or compliance with State and local laws or ordinances. Signs, barricades, barriers, channelizing devices, pavement markings, etc., shall comply with plan details, the MUTCD and Section 713 of LADOTD Standard Specifications for Roads and Bridges, Latest Edition. Construction work shall not begin until signs, barricades, project signs and other traffic devices have been erected and approved.</p>			1	Lump Sum
S-00001	<p>Sawcutting (Concrete): All Labor, Materials, equipment, and supervision necessary to cut full depth concrete road panels. This item is separate and apart from cutting the joints of the road to prevent damaging another panel that is scheduled to remain.</p>			60	IN/FT
715-01-00100	<p>Topsoil Shoulder Material: LA DOTD Standard Specification for Roads and Bridges, Section 401. All labor, materials and equipment necessary to furnish and place Topsoil for shoulder material (Adjusted Vehicular Measurement). Contractor shall place specified shoulder material flush with the asphalt wearing surface course to a maximum of 12" wide. This material shall be graded uniformly throughout the project. Should any excess incidental construction material extend beyond the 12" maximum limit, the material shall be removed and properly disposed of off-site. The finished specified shoulder material shall not consist of any foreign material that is not contained with the parent material.</p>			2	Cubic Yard

All Work Shall Conform to Louisiana Standard Specifications for Roads and Bridges, Latest Edition

Panels will be marked in the field once project is ready to begin.

Item	Description	Length	Width	Quantity	Unit
<p>706-03-00500</p>	<p>Remove/Replace/Repair Concrete Panels: All labor, materials, equipment and supervision necessary to, in accordance with these specifications, and LA DOTD Standard Specifications for Roads and Bridges, Section 706 Latest Edition, Remove/Replace/Repair Concrete Pavement. Contractor shall be responsible for removal of concrete, curbing, and all base materials to a depth of 8" below the bottom grade of the new 8" thick concrete panel. Replacement base material shall be River Sand or Pumped Sand. Base repair and/or patch is not limited to a square yardage quantity, but may include the entire panel if directed by Department of Public Works inspection staff. This item is at no direct pay. Prior to contractor pouring replacement concrete panel and rollover curb, base material shall be examined by project inspector. Contractor shall inspect the project site and bid accordingly. Panels identified for removal and replacement next to and/or adjacent to new panels shall be saw-cut along the adjoining edge. Any damage caused by contractor operations shall be repaired immediately at no direct pay.</p> <p>Replacement panels shall be Fiber reinforced, 4000 psi, 8" thick concrete, with 3/4" smooth dowel bars into existing concrete pavement @ 18" on-center for butt/construction joints. Use #4 deformed bar for longitudinal joints 2' on center. Panels longer than 15' in length shall be split into two panels by means of keyway and load transfer bars.</p> <p>Joints shall be replaced in-kind, to include but not limited to expansion joints, control joints, etc., and sealed with approved joint sealing material.</p> <p>Broken concrete shall be removed and hauled to an area identified by project inspector at no direct pay.</p>			<p>180</p>	<p>Square Yard</p>

All Work Shall Conform to Louisiana Standard Specifications for Roads and Bridges, Latest Edition

Panels will be marked in the field once project is ready to begin.

Item	Description	Length	Width	Quantity	Unit
<p>706-03-00500-A</p>	<p>Remove/Replace/Repair Concrete Panels (High Early): All labor, materials, equipment and supervision necessary to, in accordance with these specifications, and LA DOTD Standard Specifications for Roads and Bridges, Section 706 Latest Edition, Remove/Replace/Repair Concrete Pavement. Contractor shall be responsible for removal of concrete and all base materials to a depth of 8" below the bottom grade of the new 8" thick concrete panel. Replacement base material shall be River Sand or Pumped Sand. Base repair and/or patch is not limited to a square yardage quantity, but may include the entire panel if directed by Department of Public Works inspection staff. This item is at no direct pay. Prior to contractor pouring replacement concrete panel and rollover curb, base material shall be examined by project inspector. Contractor shall inspect the project site and bid accordingly. Panels identified for removal and replacement next to and/or adjacent to new panels shall be saw-cut along the adjoining edge. Any damage caused by contractor operations shall be repaired immediately at no direct pay.</p> <p>Replacement panels shall be Fiber reinforced, 4000 psi @ 72 Hours, 8" thick concrete, with 3/4" smooth dowel bars into existing concrete pavement @ 18" on-center for butt/construction joints. Use #4 deformed bar for longitudinal joints 2' on center. Panels longer than 15' in length shall be split into two panels by means of keyway and load transfer bars.</p> <p>Joints shall be replaced in-kind, to include but not limited to expansion joints, control joints, etc., and sealed with approved joint sealing material.</p> <p>Broken concrete shall be removed and hauled to an area identified by project inspector at no direct pay.</p>			<p>95</p>	<p>Square Yard</p>

All Work Shall Conform to Louisiana Standard Specifications for Roads and Bridges, Latest Edition

Panels will be marked in the field once project is ready to begin.

Item	Description	Length	Width	Quantity	Unit
	<p>General Notes:</p> <ol style="list-style-type: none"> 1. Contractor shall field verify all quantities and measurements. 2. Contractor shall be responsible for locating and protecting all existing utilities. 3. Two-way traffic shall be maintained at all times during construction. Contractor shall have flagmen on both ends of work zone. If Police details are used for traffic control this does not take the place of flag men. 4. Construction work shall not begin until signs, barricades, project signs and other traffic devices have been erected and approved. Contractor shall maintain project and construction signs. 5. All existing sewer lines shall be tied-in at no direct pay. 6. Asphalt and concrete driveway tie-ins shall be tied in to existing surface material. 7. Any additional work performed by the contractor without prior written approval from St Tammany Parish Department of Engineering, the cost of the work will be borne by the contractor and will not be reimbursed by the Parish. 8. Contractor shall ensure roadway and shoulders drain accordingly without any surface ponding/"bird baths" after rain events. 9. Materials Testing: All required testing and reporting shall be the contractor's responsibility at no direct pay. Sampling and Testing will be performed in accordance with the St. Tammany Parish Roadway Testing and Inspection Standards for Residential Subdivisions (Attached with Bid Proposal) and LADOTD Standard Specifications for Roads and Bridges, Latest Edition, Section 101 and 106. 10. Roads and surrounding areas shall be dressed after 7 calendar days and no later than 10 calendar days after opening of street. Late Fee of \$1.00 per Linear Foot per Calendar Day shall be charged if not completed with the specified time frame. 11. If any driveways are impacted, contractor shall give resident 24 hour notice that they need to move vehicles so as to not get blocked in and that they will not be able to access the driveway for three days after pouring concrete. 				
	<p>Project Summary: Contractor shall provide all labor, materials, equipment and supervision necessary to Remove, Replace and/or Repair Concrete Panels and Concrete Rollover/Barrier Curbs.</p>				
727-01	<p>Mobilization: All labor and materials necessary to accomplish preparatory work and operations, including those necessary for movement of personnel, equipment, supplies and incidentals to the project site.</p>			1	Lump Sum

All Work Shall Conform to Louisiana Standard Specifications for Roads and Bridges, Latest Edition

Panels will be marked in the field once project is ready to begin.

Item	Description	Length	Width	Quantity	Unit
713-01	<p>Temporary Signs and Barricades: All labor, materials, equipment and supervision necessary to furnish, install, maintain and remove temporary construction barricades, precast concrete barriers, lights, signals, pavement markings and signs, including project signs; providing flaggers; and complying with all other requirements regarding the protection of the work, workers and safety of the public. Unless otherwise noted in the plans or special provisions this work also includes traffic control management in compliance with contract documents and the Manual on Uniform Traffic Control Devices (MUTCD), including the installation, inspection, maintenance, and removal of all traffic control devices on the project. This item shall not be construed to relieve the contractor of responsibilities for the safety of the public, for liability in connection therewith, or compliance with State and local laws or ordinances. Signs, barricades, barriers, channelizing devices, pavement markings, etc., shall comply with plan details, the MUTCD and Section 713 of LADOTD Standard Specifications for Roads and Bridges, Latest Edition. Construction work shall not begin until signs, barricades, project signs and other traffic devices have been erected and approved.</p>			1	Lump Sum
S-00001	<p>Sawcutting (Concrete): All Labor, Materials, equipment, and supervision necessary to cut full depth concrete road panels. This item is separate and apart from cutting the joints of the road to prevent damaging another panel that is scheduled to remain.</p>			200	IN/FT
715-01-00100	<p>Topsoil Shoulder Material: LA DOTD Standard Specification for Roads and Bridges, Section 401. All labor, materials and equipment necessary to furnish and place Topsoil for shoulder material (Adjusted Vehicular Measurement). Contractor shall place specified shoulder material flush with the asphalt wearing surface course to a maximum of 12" wide. This material shall be graded uniformly throughout the project. Should any excess incidental construction material extend beyond the 12" maximum limit, the material shall be removed and properly disposed of off-site. The finished specified shoulder material shall not consist of any foreign material that is not contained with the parent material.</p>			12	Cubic Yard

All Work Shall Conform to Louisiana Standard Specifications for Roads and Bridges, Latest Edition

Panels will be marked in the field once project is ready to begin.

Item	Description	Length	Width	Quantity	Unit
706-03-00500	<p>Remove/Replace/Repair Concrete Panels: All labor, materials, equipment and supervision necessary to, in accordance with these specifications, and LA DOTD Standard Specifications for Roads and Bridges, Section 706 Latest Edition, Remove/Replace/Repair Concrete Pavement. Contractor shall be responsible for removal of concrete, curbing, and all base materials to a depth of 8" below the bottom grade of the new 8" thick concrete panel. Replacement base material shall be River Sand or Pumped Sand. Base repair and/or patch is not limited to a square yardage quantity, but may include the entire panel if directed by Department of Public Works inspection staff. This item is at no direct pay. Prior to contractor pouring replacement concrete panel and rollover curb, base material shall be examined by project inspector. Contractor shall inspect the project site and bid accordingly. Panels identified for removal and replacement next to and/or adjacent to new panels shall be saw-cut along the adjoining edge. Any damage caused by contractor operations shall be repaired immediately at no direct pay.</p> <p>Replacement panels shall be Fiber reinforced, 4000 psi, 8" thick concrete, with 3/4" smooth dowel bars into existing concrete pavement @ 18" on-center for butt/construction joints. Use #4 deformed bar for longitudinal joints 2' on center. Panels longer than 15' in length shall be split into two panels by means of keyway and load transfer bars.</p> <p>Joints shall be replaced in-kind, to include but not limited to expansion joints, control joints, etc., and sealed with approved joint sealing material.</p> <p>Broken concrete shall be removed and hauled to an area identified by project inspector at no direct pay.</p>			550	Square Yard

All Work Shall Conform to Louisiana Standard Specifications for Roads and Bridges, Latest Edition

Panels will be marked in the field once project is ready to begin.

Item	Description	Length	Width	Quantity	Unit
706-03-00500-A	<p>Remove/Replace/Repair Concrete Panels (High Early): All labor, materials, equipment and supervision necessary to, in accordance with these specifications, and LA DOTD Standard Specifications for Roads and Bridges, Section 706 Latest Edition, Remove/Replace/Repair Concrete Pavement. Contractor shall be responsible for removal of concrete and all base materials to a depth of 8" below the bottom grade of the new 8" thick concrete panel. Replacement base material shall be River Sand or Pumped Sand. Base repair and/or patch is not limited to a square yardage quantity, but may include the entire panel if directed by Department of Public Works inspection staff. This item is at no direct pay. Prior to contractor pouring replacement concrete panel and rollover curb, base material shall be examined by project inspector. Contractor shall inspect the project site and bid accordingly. Panels identified for removal and replacement next to and/or adjacent to new panels shall be saw-cut along the adjoining edge. Any damage caused by contractor operations shall be repaired immediately at no direct pay.</p> <p>Replacement panels shall be Fiber reinforced, 4000 psi @ 72 Hours, 8" thick concrete, with 3/4" smooth dowel bars into existing concrete pavement @ 18" on-center for butt/construction joints. Use #4 deformed bar for longitudinal joints 2' on center. Panels longer than 15' in length shall be split into two panels by means of keyway and load transfer bars.</p> <p>Joints shall be replaced in-kind, to include but not limited to expansion joints, control joints, etc., and sealed with approved joint sealing material.</p> <p>Broken concrete shall be removed and hauled to an area identified by project inspector at no direct pay.</p>			132	Square Yard

All Work Shall Conform to Louisiana Standard Specifications for Roads and Bridges, Latest Edition

Panels will be marked in the field once project is ready to begin.

Item	Description	Length	Width	Quantity	Unit
	<p>General Notes:</p> <ol style="list-style-type: none"> 1. Contractor shall field verify all quantities and measurements. 2. Contractor shall be responsible for locating and protecting all existing utilities. 3. Two-way traffic shall be maintained at all times during construction. Contractor shall have flagmen on both ends of work zone. If Police details are used for traffic control this does not take the place of flag men. 4. Construction work shall not begin until signs, barricades, project signs and other traffic devices have been erected and approved. Contractor shall maintain project and construction signs. 5. All existing sewer lines shall be tied-in at no direct pay. 6. Asphalt and concrete driveway tie-ins shall be tied in to existing surface material. 7. Any additional work performed by the contractor without prior written approval from St Tammany Parish Department of Engineering, the cost of the work will be borne by the contractor and will not be reimbursed by the Parish. 8. Contractor shall ensure roadway and shoulders drain accordingly without any surface ponding/"bird baths" after rain events. 9. Materials Testing: All required testing and reporting shall be the contractor's responsibility at no direct pay. Sampling and Testing will be performed in accordance with the St. Tammany Parish Roadway Testing and Inspection Standards for Residential Subdivisions (Attached with Bid Proposal) and LADOTD Standard Specifications for Roads and Bridges, Latest Edition, Section 101 and 106. 10. Roads and surrounding areas shall be dressed after 7 calendar days and no later than 10 calendar days after opening of street. Late Fee of \$1.00 per Linear Foot per Calendar Day shall be charged if not completed with the specified time frame. 11. If any driveways are impacted, contractor shall give resident 24 hour notice that they need to move vehicles so as to not get blocked in and that they will not be able to access the driveway for three days after pouring concrete. 				
	<p>Project Summary: Contractor shall provide all labor, materials, equipment and supervision necessary to Remove, Replace and/or Repair Concrete Panels and Concrete Rollover/Barrier Curbs.</p>				
727-01	<p>Mobilization: All labor and materials necessary to accomplish preparatory work and operations, including those necessary for movement of personnel, equipment, supplies and incidentals to the project site.</p>			1	Lump Sum

All Work Shall Conform to Louisiana Standard Specifications for Roads and Bridges, Latest Edition

Panels will be marked in the field once project is ready to begin.

Item	Description	Length	Width	Quantity	Unit
713-01	Temporary Signs and Barricades: All labor, materials, equipment and supervision necessary to furnish, install, maintain and remove temporary construction barricades, precast concrete barriers, lights, signals, pavement markings and signs, including project signs ; providing flaggers; and complying with all other requirements regarding the protection of the work, workers and safety of the public. Unless otherwise noted in the plans or special provisions this work also includes traffic control management in compliance with contract documents and the Manual on Uniform Traffic Control Devices (MUTCD), including the installation, inspection, maintenance, and removal of all traffic control devices on the project. This item shall not be construed to relieve the contractor of responsibilities for the safety of the public, for liability in connection therewith, or compliance with State and local laws or ordinances. Signs, barricades, barriers, channelizing devices, pavement markings, etc., shall comply with plan details, the MUTCD and Section 713 of LADOTD Standard Specifications for Roads and Bridges, Latest Edition. Construction work shall not begin until signs, barricades, project signs and other traffic devices have been erected and approved.			1	Lump Sum
S-00001	Sawcutting (Concrete): All Labor, Materials, equipment, and supervision necessary to cut full depth concrete road panels. This item is separate and apart from cutting the joints of the road to prevent damaging another panel that is scheduled to remain.			200	IN/FT
715-01-00100	Topsoil Shoulder Material: LA DOTD Standard Specification for Roads and Bridges, Section 401. All labor, materials and equipment necessary to furnish and place Topsoil for shoulder material (Adjusted Vehicular Measurement). Contractor shall place specified shoulder material flush with the asphalt wearing surface course to a maximum of 12" wide. This material shall be graded uniformly throughout the project. Should any excess incidental construction material extend beyond the 12" maximum limit, the material shall be removed and properly disposed of off-site. The finished specified shoulder material shall not consist of any foreign material that is not contained with the parent material.			12	Cubic Yard

All Work Shall Conform to Louisiana Standard Specifications for Roads and Bridges, Latest Edition

Panels will be marked in the field once project is ready to begin.

Item	Description	Length	Width	Quantity	Unit
706-03-00500	<p>Remove/Replace/Repair Concrete Panels: All labor, materials, equipment and supervision necessary to, in accordance with these specifications, and LA DOTD Standard Specifications for Roads and Bridges, Section 706 Latest Edition, Remove/Replace/Repair Concrete Pavement. Contractor shall be responsible for removal of concrete, curbing, and all base materials to a depth of 8" below the bottom grade of the new 8" thick concrete panel. Replacement base material shall be River Sand or Pumped Sand. Base repair and/or patch is not limited to a square yardage quantity, but may include the entire panel if directed by Department of Public Works inspection staff. This item is at no direct pay. Prior to contractor pouring replacement concrete panel and rollover curb, base material shall be examined by project inspector. Contractor shall inspect the project site and bid accordingly. Panels identified for removal and replacement next to and/or adjacent to new panels shall be saw-cut along the adjoining edge. Any damage caused by contractor operations shall be repaired immediately at no direct pay.</p> <p>Replacement panels shall be Fiber reinforced, 4000 psi, 8" thick concrete, with 3/4" smooth dowel bars into existing concrete pavement @ 18" on-center for butt/construction joints. Use #4 deformed bar for longitudinal joints 2' on center. Panels longer than 15' in length shall be split into two panels by means of keyway and load transfer bars.</p> <p>Joints shall be replaced in-kind, to include but not limited to expansion joints, control joints, etc., and sealed with approved joint sealing material.</p> <p>Broken concrete shall be removed and hauled to an area identified by project inspector at no direct pay.</p>			550	Square Yard

All Work Shall Conform to Louisiana Standard Specifications for Roads and Bridges, Latest Edition

Panels will be marked in the field once project is ready to begin.

Item	Description	Length	Width	Quantity	Unit
706-03-00500-A	<p>Remove/Replace/Repair Concrete Panels (High Early): All labor, materials, equipment and supervision necessary to, in accordance with these specifications, and LA DOTD Standard Specifications for Roads and Bridges, Section 706 Latest Edition, Remove/Replace/Repair Concrete Pavement. Contractor shall be responsible for removal of concrete and all base materials to a depth of 8" below the bottom grade of the new 8" thick concrete panel. Replacement base material shall be River Sand or Pumped Sand. Base repair and/or patch is not limited to a square yardage quantity, but may include the entire panel if directed by Department of Public Works inspection staff. This item is at no direct pay. Prior to contractor pouring replacement concrete panel and rollover curb, base material shall be examined by project inspector. Contractor shall inspect the project site and bid accordingly. Panels identified for removal and replacement next to and/or adjacent to new panels shall be saw-cut along the adjoining edge. Any damage caused by contractor operations shall be repaired immediately at no direct pay.</p> <p>Replacement panels shall be Fiber reinforced, 4000 psi @ 72 Hours, 8" thick concrete, with 3/4" smooth dowel bars into existing concrete pavement @ 18" on-center for butt/construction joints. Use #4 deformed bar for longitudinal joints 2' on center. Panels longer than 15' in length shall be split into two panels by means of keyway and load transfer bars.</p> <p>Joints shall be replaced in-kind, to include but not limited to expansion joints, control joints, etc., and sealed with approved joint sealing material.</p> <p>Broken concrete shall be removed and hauled to an area identified by project inspector at no direct pay.</p>			132	Square Yard

All Work Shall Conform to Louisiana Standard Specifications for Roads and Bridges, Latest Edition

Panels will be marked in the field once project is ready to begin.

Item	Description	Length	Width	Quantity	Unit
	<p>General Notes:</p> <ol style="list-style-type: none"> 1. Contractor shall field verify all quantities and measurements. 2. Contractor shall be responsible for locating and protecting all existing utilities. 3. Two-way traffic shall be maintained at all times during construction. Contractor shall have flagmen on both ends of work zone. If Police details are used for traffic control this does not take the place of flag men. 4. Construction work shall not begin until signs, barricades, project signs and other traffic devices have been erected and approved. Contractor shall maintain project and construction signs. 5. All existing sewer lines shall be tied-in at no direct pay. 6. Asphalt and concrete driveway tie-ins shall be tied in to existing surface material. 7. Any additional work performed by the contractor without prior written approval from St Tammany Parish Department of Engineering, the cost of the work will be borne by the contractor and will not be reimbursed by the Parish. 8. Contractor shall ensure roadway and shoulders drain accordingly without any surface ponding/"bird baths" after rain events. 9. Materials Testing: All required testing and reporting shall be the contractor's responsibility at no direct pay. Sampling and Testing will be performed in accordance with the St. Tammany Parish Roadway Testing and Inspection Standards for Residential Subdivisions (Attached with Bid Proposal) and LADOTD Standard Specifications for Roads and Bridges, Latest Edition, Section 101 and 106. 10. Roads and surrounding areas shall be dressed after 7 calendar days and no later than 10 calendar days after opening of street. Late Fee of \$1.00 per Linear Foot per Calendar Day shall be charged if not completed with the specified time frame. 11. If any driveways are impacted, contractor shall give resident 24 hour notice that they need to move vehicles so as to not get blocked in and that they will not be able to access the driveway for three days after pouring concrete. 				
	<p>Project Summary: Contractor shall provide all labor, materials, equipment and supervision necessary to Remove, Replace and/or Repair Concrete Panels and Concrete Rollover/Barrier Curbs.</p>				
727-01	<p>Mobilization: All labor and materials necessary to accomplish preparatory work and operations, including those necessary for movement of personnel, equipment, supplies and incidentals to the project site.</p>			1	Lump Sum

All Work Shall Conform to Louisiana Standard Specifications for Roads and Bridges, Latest Edition

Panels will be marked in the field once project is ready to begin.

Item	Description	Length	Width	Quantity	Unit
713-01	<p>Temporary Signs and Barricades: All labor, materials, equipment and supervision necessary to furnish, install, maintain and remove temporary construction barricades, precast concrete barriers, lights, signals, pavement markings and signs, including project signs; providing flaggers; and complying with all other requirements regarding the protection of the work, workers and safety of the public. Unless otherwise noted in the plans or special provisions this work also includes traffic control management in compliance with contract documents and the Manual on Uniform Traffic Control Devices (MUTCD), including the installation, inspection, maintenance, and removal of all traffic control devices on the project. This item shall not be construed to relieve the contractor of responsibilities for the safety of the public, for liability in connection therewith, or compliance with State and local laws or ordinances. Signs, barricades, barriers, channelizing devices, pavement markings, etc., shall comply with plan details, the MUTCD and Section 713 of LADOTD Standard Specifications for Roads and Bridges, Latest Edition. Construction work shall not begin until signs, barricades, project signs and other traffic devices have been erected and approved.</p>			1	Lump Sum
S-00001	<p>Sawcutting (Concrete): All Labor, Materials, equipment, and supervision necessary to cut full depth concrete road panels. This item is separate and apart from cutting the joints of the road to prevent damaging another panel that is scheduled to remain.</p>			200	IN/FT
715-01-00100	<p>Topsoil Shoulder Material: LA DOTD Standard Specification for Roads and Bridges, Section 401. All labor, materials and equipment necessary to furnish and place Topsoil for shoulder material (Adjusted Vehicular Measurement). Contractor shall place specified shoulder material flush with the asphalt wearing surface course to a maximum of 12" wide. This material shall be graded uniformly throughout the project. Should any excess incidental construction material extend beyond the 12" maximum limit, the material shall be removed and properly disposed of off-site. The finished specified shoulder material shall not consist of any foreign material that is not contained with the parent material.</p>			12	Cubic Yard

All Work Shall Conform to Louisiana Standard Specifications for Roads and Bridges, Latest Edition

Panels will be marked in the field once project is ready to begin.

Item	Description	Length	Width	Quantity	Unit
706-03-00500	<p>Remove/Replace/Repair Concrete Panels: All labor, materials, equipment and supervision necessary to, in accordance with these specifications, and LA DOTD Standard Specifications for Roads and Bridges, Section 706 Latest Edition, Remove/Replace/Repair Concrete Pavement. Contractor shall be responsible for removal of concrete, curbing, and all base materials to a depth of 8" below the bottom grade of the new 8" thick concrete panel. Replacement base material shall be River Sand or Pumped Sand. Base repair and/or patch is not limited to a square yardage quantity, but may include the entire panel if directed by Department of Public Works inspection staff. This item is at no direct pay. Prior to contractor pouring replacement concrete panel and rollover curb, base material shall be examined by project inspector. Contractor shall inspect the project site and bid accordingly. Panels identified for removal and replacement next to and/or adjacent to new panels shall be saw-cut along the adjoining edge. Any damage caused by contractor operations shall be repaired immediately at no direct pay.</p> <p>Replacement panels shall be Fiber reinforced, 4000 psi, 8" thick concrete, with 3/4" smooth dowel bars into existing concrete pavement @ 18" on-center for butt/construction joints. Use #4 deformed bar for longitudinal joints 2' on center. Panels longer than 15' in length shall be split into two panels by means of keyway and load transfer bars.</p> <p>Joints shall be replaced in-kind, to include but not limited to expansion joints, control joints, etc., and sealed with approved joint sealing material.</p> <p>Broken concrete shall be removed and hauled to an area identified by project inspector at no direct pay.</p>			550	Square Yard

All Work Shall Conform to Louisiana Standard Specifications for Roads and Bridges, Latest Edition

Panels will be marked in the field once project is ready to begin.

Item	Description	Length	Width	Quantity	Unit
706-03-00500-A	<p>Remove/Replace/Repair Concrete Panels (High Early): All labor, materials, equipment and supervision necessary to, in accordance with these specifications, and LA DOTD Standard Specifications for Roads and Bridges, Section 706 Latest Edition, Remove/Replace/Repair Concrete Pavement. Contractor shall be responsible for removal of concrete and all base materials to a depth of 8" below the bottom grade of the new 8" thick concrete panel. Replacement base material shall be River Sand or Pumped Sand. Base repair and/or patch is not limited to a square yardage quantity, but may include the entire panel if directed by Department of Public Works inspection staff. This item is at no direct pay. Prior to contractor pouring replacement concrete panel and rollover curb, base material shall be examined by project inspector. Contractor shall inspect the project site and bid accordingly. Panels identified for removal and replacement next to and/or adjacent to new panels shall be saw-cut along the adjoining edge. Any damage caused by contractor operations shall be repaired immediately at no direct pay.</p> <p>Replacement panels shall be Fiber reinforced, 4000 psi @ 72 Hours, 8" thick concrete, with 3/4" smooth dowel bars into existing concrete pavement @ 18" on-center for butt/construction joints. Use #4 deformed bar for longitudinal joints 2' on center. Panels longer than 15' in length shall be split into two panels by means of keyway and load transfer bars.</p> <p>Joints shall be replaced in-kind, to include but not limited to expansion joints, control joints, etc., and sealed with approved joint sealing material.</p> <p>Broken concrete shall be removed and hauled to an area identified by project inspector at no direct pay.</p>			132	Square Yard

All Work Shall Conform to Louisiana Standard Specifications for Roads and Bridges, Latest Edition

Panels will be marked in the field once project is ready to begin.

Item	Description	Length	Width	Quantity	Unit
	<p>General Notes:</p> <ol style="list-style-type: none"> 1. Contractor shall field verify all quantities and measurements. 2. Contractor shall be responsible for locating and protecting all existing utilities. 3. Two-way traffic shall be maintained at all times during construction. Contractor shall have flagmen on both ends of work zone. If Police details are used for traffic control this does not take the place of flag men. 4. Construction work shall not begin until signs, barricades, project signs and other traffic devices have been erected and approved. Contractor shall maintain project and construction signs. 5. All existing sewer lines shall be tied-in at no direct pay. 6. Asphalt and concrete driveway tie-ins shall be tied in to existing surface material. 7. Any additional work performed by the contractor without prior written approval from St Tammany Parish Department of Engineering, the cost of the work will be borne by the contractor and will not be reimbursed by the Parish. 8. Contractor shall ensure roadway and shoulders drain accordingly without any surface ponding/"bird baths" after rain events. 9. Materials Testing: All required testing and reporting shall be the contractor's responsibility at no direct pay. Sampling and Testing will be performed in accordance with the St. Tammany Parish Roadway Testing and Inspection Standards for Residential Subdivisions (Attached with Bid Proposal) and LADOTD Standard Specifications for Roads and Bridges, Latest Edition, Section 101 and 106. 10. Roads and surrounding areas shall be dressed after 7 calendar days and no later than 10 calendar days after opening of street. Late Fee of \$1.00 per Linear Foot per Calendar Day shall be charged if not completed with the specified time frame. 11. If any driveways are impacted, contractor shall give resident 24 hour notice that they need to move vehicles so as to not get blocked in and that they will not be able to access the driveway for three days after pouring concrete. 				
	<p>Project Summary: Contractor shall provide all labor, materials, equipment and supervision necessary to Remove, Replace and/or Repair Concrete Panels and Concrete Rollover/Barrier Curbs.</p>				
727-01	<p>Mobilization: All labor and materials necessary to accomplish preparatory work and operations, including those necessary for movement of personnel, equipment, supplies and incidentals to the project site.</p>			1	Lump Sum

All Work Shall Conform to Louisiana Standard Specifications for Roads and Bridges, Latest Edition

Panels will be marked in the field once project is ready to begin.

Item	Description	Length	Width	Quantity	Unit
713-01	<p>Temporary Signs and Barricades: All labor, materials, equipment and supervision necessary to furnish, install, maintain and remove temporary construction barricades, precast concrete barriers, lights, signals, pavement markings and signs, including project signs; providing flaggers; and complying with all other requirements regarding the protection of the work, workers and safety of the public. Unless otherwise noted in the plans or special provisions this work also includes traffic control management in compliance with contract documents and the Manual on Uniform Traffic Control Devices (MUTCD), including the installation, inspection, maintenance, and removal of all traffic control devices on the project. This item shall not be construed to relieve the contractor of responsibilities for the safety of the public, for liability in connection therewith, or compliance with State and local laws or ordinances. Signs, barricades, barriers, channelizing devices, pavement markings, etc., shall comply with plan details, the MUTCD and Section 713 of LADOTD Standard Specifications for Roads and Bridges, Latest Edition. Construction work shall not begin until signs, barricades, project signs and other traffic devices have been erected and approved.</p>			1	Lump Sum
S-00001	<p>Sawcutting (Concrete): All Labor, Materials, equipment, and supervision necessary to cut full depth concrete road panels. This item is separate and apart from cutting the joints of the road to prevent damaging another panel that is scheduled to remain.</p>			90	IN/FT
715-01-00100	<p>Topsoil Shoulder Material: LA DOTD Standard Specification for Roads and Bridges, Section 401. All labor, materials and equipment necessary to furnish and place Topsoil for shoulder material (Adjusted Vehicular Measurement). Contractor shall place specified shoulder material flush with the asphalt wearing surface course to a maximum of 12" wide. This material shall be graded uniformly throughout the project. Should any excess incidental construction material extend beyond the 12" maximum limit, the material shall be removed and properly disposed of off-site. The finished specified shoulder material shall not consist of any foreign material that is not contained with the parent material.</p>			6	Cubic Yard

All Work Shall Conform to Louisiana Standard Specifications for Roads and Bridges, Latest Edition

Panels will be marked in the field once project is ready to begin.

Item	Description	Length	Width	Quantity	Unit
<p>706-03-00500</p>	<p>Remove/Replace/Repair Concrete Panels: All labor, materials, equipment and supervision necessary to, in accordance with these specifications, and LA DOTD Standard Specifications for Roads and Bridges, Section 706 Latest Edition, Remove/Replace/Repair Concrete Pavement. Contractor shall be responsible for removal of concrete, curbing, and all base materials to a depth of 8" below the bottom grade of the new 8" thick concrete panel. Replacement base material shall be River Sand or Pumped Sand. Base repair and/or patch is not limited to a square yardage quantity, but may include the entire panel if directed by Department of Public Works inspection staff. This item is at no direct pay. Prior to contractor pouring replacement concrete panel and rollover curb, base material shall be examined by project inspector. Contractor shall inspect the project site and bid accordingly. Panels identified for removal and replacement next to and/or adjacent to new panels shall be saw-cut along the adjoining edge. Any damage caused by contractor operations shall be repaired immediately at no direct pay.</p> <p>Replacement panels shall be Fiber reinforced, 4000 psi, 8" thick concrete, with 3/4" smooth dowel bars into existing concrete pavement @ 18" on-center for butt/construction joints. Use #4 deformed bar for longitudinal joints 2' on center. Panels longer than 15' in length shall be split into two panels by means of keyway and load transfer bars.</p> <p>Joints shall be replaced in-kind, to include but not limited to expansion joints, control joints, etc., and sealed with approved joint sealing material.</p> <p>Broken concrete shall be removed and hauled to an area identified by project inspector at no direct pay.</p>			<p>260</p>	<p>Square Yard</p>

All Work Shall Conform to Louisiana Standard Specifications for Roads and Bridges, Latest Edition

Panels will be marked in the field once project is ready to begin.

Item	Description	Length	Width	Quantity	Unit
706-03-00500-A	<p>Remove/Replace/Repair Concrete Panels (High Early): All labor, materials, equipment and supervision necessary to, in accordance with these specifications, and LA DOTD Standard Specifications for Roads and Bridges, Section 706 Latest Edition, Remove/Replace/Repair Concrete Pavement. Contractor shall be responsible for removal of concrete and all base materials to a depth of 8" below the bottom grade of the new 8" thick concrete panel. Replacement base material shall be River Sand or Pumped Sand. Base repair and/or patch is not limited to a square yardage quantity, but may include the entire panel if directed by Department of Public Works inspection staff. This item is at no direct pay. Prior to contractor pouring replacement concrete panel and rollover curb, base material shall be examined by project inspector. Contractor shall inspect the project site and bid accordingly. Panels identified for removal and replacement next to and/or adjacent to new panels shall be saw-cut along the adjoining edge. Any damage caused by contractor operations shall be repaired immediately at no direct pay.</p> <p>Replacement panels shall be Fiber reinforced, 4000 psi @ 72 Hours, 8" thick concrete, with 3/4" smooth dowel bars into existing concrete pavement @ 18" on-center for butt/construction joints. Use #4 deformed bar for longitudinal joints 2' on center. Panels longer than 15' in length shall be split into two panels by means of keyway and load transfer bars.</p> <p>Joints shall be replaced in-kind, to include but not limited to expansion joints, control joints, etc., and sealed with approved joint sealing material.</p> <p>Broken concrete shall be removed and hauled to an area identified by project inspector at no direct pay.</p>			80	Square Yard

All Work Shall Conform to Louisiana Standard Specifications for Roads and Bridges, Latest Edition

Panels will be marked in the field once project is ready to begin.

Item	Description	Length	Width	Quantity	Unit
	<p>General Notes:</p> <ol style="list-style-type: none"> 1. Contractor shall field verify all quantities and measurements. 2. Contractor shall be responsible for locating and protecting all existing utilities. 3. Two-way traffic shall be maintained at all times during construction. Contractor shall have flagmen on both ends of work zone. If Police details are used for traffic control this does not take the place of flag men. 4. Construction work shall not begin until signs, barricades, project signs and other traffic devices have been erected and approved. Contractor shall maintain project and construction signs. 5. All existing sewer lines shall be tied-in at no direct pay. 6. Asphalt and concrete driveway tie-ins shall be tied in to existing surface material. 7. Any additional work performed by the contractor without prior written approval from St Tammany Parish Department of Engineering, the cost of the work will be borne by the contractor and will not be reimbursed by the Parish. 8. Contractor shall ensure roadway and shoulders drain accordingly without any surface ponding/"bird baths" after rain events. 9. Materials Testing: All required testing and reporting shall be the contractor's responsibility at no direct pay. Sampling and Testing will be performed in accordance with the St. Tammany Parish Roadway Testing and Inspection Standards for Residential Subdivisions (Attached with Bid Proposal) and LADOTD Standard Specifications for Roads and Bridges, Latest Edition, Section 101 and 106. 10. Roads and surrounding areas shall be dressed after 7 calendar days and no later than 10 calendar days after opening of street. Late Fee of \$1.00 per Linear Foot per Calendar Day shall be charged if not completed with the specified time frame. 11. If any driveways are impacted, contractor shall give resident 24 hour notice that they need to move vehicles so as to not get blocked in and that they will not be able to access the driveway for three days after pouring concrete. 				
	<p>Project Summary: Contractor shall provide all labor, materials, equipment and supervision necessary to Remove, Replace and/or Repair Concrete Panels and Concrete Rollover/Barrier Curbs.</p>				
727-01	<p>Mobilization: All labor and materials necessary to accomplish preparatory work and operations, including those necessary for movement of personnel, equipment, supplies and incidentals to the project site.</p>			1	Lump Sum

All Work Shall Conform to Louisiana Standard Specifications for Roads and Bridges, Latest Edition

Panels will be marked in the field once project is ready to begin.

Item	Description	Length	Width	Quantity	Unit
713-01	Temporary Signs and Barricades: All labor, materials, equipment and supervision necessary to furnish, install, maintain and remove temporary construction barricades, precast concrete barriers, lights, signals, pavement markings and signs, including project signs ; providing flaggers; and complying with all other requirements regarding the protection of the work, workers and safety of the public. Unless otherwise noted in the plans or special provisions this work also includes traffic control management in compliance with contract documents and the Manual on Uniform Traffic Control Devices (MUTCD), including the installation, inspection, maintenance, and removal of all traffic control devices on the project. This item shall not be construed to relieve the contractor of responsibilities for the safety of the public, for liability in connection therewith, or compliance with State and local laws or ordinances. Signs, barricades, barriers, channelizing devices, pavement markings, etc., shall comply with plan details, the MUTCD and Section 713 of LADOTD Standard Specifications for Roads and Bridges, Latest Edition. Construction work shall not begin until signs, barricades, project signs and other traffic devices have been erected and approved.			1	Lump Sum
S-00001	Sawcutting (Concrete): All Labor, Materials, equipment, and supervision necessary to cut full depth concrete road panels. This item is separate and apart from cutting the joints of the road to prevent damaging another panel that is scheduled to remain.			90	IN/FT
715-01-00100	Topsoil Shoulder Material: LA DOTD Standard Specification for Roads and Bridges, Section 401. All labor, materials and equipment necessary to furnish and place Topsoil for shoulder material (Adjusted Vehicular Measurement). Contractor shall place specified shoulder material flush with the asphalt wearing surface course to a maximum of 12" wide. This material shall be graded uniformly throughout the project. Should any excess incidental construction material extend beyond the 12" maximum limit, the material shall be removed and properly disposed of off-site. The finished specified shoulder material shall not consist of any foreign material that is not contained with the parent material.			6	Cubic Yard

All Work Shall Conform to Louisiana Standard Specifications for Roads and Bridges, Latest Edition

Panels will be marked in the field once project is ready to begin.

Item	Description	Length	Width	Quantity	Unit
<p>706-03-00500</p>	<p>Remove/Replace/Repair Concrete Panels: All labor, materials, equipment and supervision necessary to, in accordance with these specifications, and LA DOTD Standard Specifications for Roads and Bridges, Section 706 Latest Edition, Remove/Replace/Repair Concrete Pavement. Contractor shall be responsible for removal of concrete, curbing, and all base materials to a depth of 8" below the bottom grade of the new 8" thick concrete panel. Replacement base material shall be River Sand or Pumped Sand. Base repair and/or patch is not limited to a square yardage quantity, but may include the entire panel if directed by Department of Public Works inspection staff. This item is at no direct pay. Prior to contractor pouring replacement concrete panel and rollover curb, base material shall be examined by project inspector. Contractor shall inspect the project site and bid accordingly. Panels identified for removal and replacement next to and/or adjacent to new panels shall be saw-cut along the adjoining edge. Any damage caused by contractor operations shall be repaired immediately at no direct pay.</p> <p>Replacement panels shall be Fiber reinforced, 4000 psi, 8" thick concrete, with 3/4" smooth dowel bars into existing concrete pavement @ 18" on-center for butt/construction joints. Use #4 deformed bar for longitudinal joints 2' on center. Panels longer than 15' in length shall be split into two panels by means of keyway and load transfer bars.</p> <p>Joints shall be replaced in-kind, to include but not limited to expansion joints, control joints, etc., and sealed with approved joint sealing material.</p> <p>Broken concrete shall be removed and hauled to an area identified by project inspector at no direct pay.</p>			<p>260</p>	<p>Square Yard</p>

All Work Shall Conform to Louisiana Standard Specifications for Roads and Bridges, Latest Edition

Panels will be marked in the field once project is ready to begin.

Item	Description	Length	Width	Quantity	Unit
<p>706-03-00500-A</p>	<p>Remove/Replace/Repair Concrete Panels (High Early): All labor, materials, equipment and supervision necessary to, in accordance with these specifications, and LA DOTD Standard Specifications for Roads and Bridges, Section 706 Latest Edition, Remove/Replace/Repair Concrete Pavement. Contractor shall be responsible for removal of concrete and all base materials to a depth of 8" below the bottom grade of the new 8" thick concrete panel. Replacement base material shall be River Sand or Pumped Sand. Base repair and/or patch is not limited to a square yardage quantity, but may include the entire panel if directed by Department of Public Works inspection staff. This item is at no direct pay. Prior to contractor pouring replacement concrete panel and rollover curb, base material shall be examined by project inspector. Contractor shall inspect the project site and bid accordingly. Panels identified for removal and replacement next to and/or adjacent to new panels shall be saw-cut along the adjoining edge. Any damage caused by contractor operations shall be repaired immediately at no direct pay.</p> <p>Replacement panels shall be Fiber reinforced, 4000 psi @ 72 Hours, 8" thick concrete, with 3/4" smooth dowel bars into existing concrete pavement @ 18" on-center for butt/construction joints. Use #4 deformed bar for longitudinal joints 2' on center. Panels longer than 15' in length shall be split into two panels by means of keyway and load transfer bars.</p> <p>Joints shall be replaced in-kind, to include but not limited to expansion joints, control joints, etc., and sealed with approved joint sealing material.</p> <p>Broken concrete shall be removed and hauled to an area identified by project inspector at no direct pay.</p>			<p>80</p>	<p>Square Yard</p>

All Work Shall Conform to Louisiana Standard Specifications for Roads and Bridges, Latest Edition

Panels will be marked in the field once project is ready to begin.

Item	Description	Length	Width	Quantity	Unit
	<p>General Notes:</p> <ol style="list-style-type: none"> 1. Contractor shall field verify all quantities and measurements. 2. Contractor shall be responsible for locating and protecting all existing utilities. 3. Two-way traffic shall be maintained at all times during construction. Contractor shall have flagmen on both ends of work zone. If Police details are used for traffic control this does not take the place of flag men. 4. Construction work shall not begin until signs, barricades, project signs and other traffic devices have been erected and approved. Contractor shall maintain project and construction signs. 5. All existing sewer lines shall be tied-in at no direct pay. 6. Asphalt and concrete driveway tie-ins shall be tied in to existing surface material. 7. Any additional work performed by the contractor without prior written approval from St Tammany Parish Department of Engineering, the cost of the work will be borne by the contractor and will not be reimbursed by the Parish. 8. Contractor shall ensure roadway and shoulders drain accordingly without any surface ponding/"bird baths" after rain events. 9. Materials Testing: All required testing and reporting shall be the contractor's responsibility at no direct pay. Sampling and Testing will be performed in accordance with the St. Tammany Parish Roadway Testing and Inspection Standards for Residential Subdivisions (Attached with Bid Proposal) and LADOTD Standard Specifications for Roads and Bridges, Latest Edition, Section 101 and 106. 10. Roads and surrounding areas shall be dressed after 7 calendar days and no later than 10 calendar days after opening of street. Late Fee of \$1.00 per Linear Foot per Calendar Day shall be charged if not completed with the specified time frame. 11. If any driveways are impacted, contractor shall give resident 24 hour notice that they need to move vehicles so as to not get blocked in and that they will not be able to access the driveway for three days after pouring concrete. 				
	<p>Project Summary: Contractor shall provide all labor, materials, equipment and supervision necessary to Remove, Replace and/or Repair Concrete Panels and Concrete Rollover/Barrier Curbs.</p>				
727-01	<p>Mobilization: All labor and materials necessary to accomplish preparatory work and operations, including those necessary for movement of personnel, equipment, supplies and incidentals to the project site.</p>			1	Lump Sum

All Work Shall Conform to Louisiana Standard Specifications for Roads and Bridges, Latest Edition

Panels will be marked in the field once project is ready to begin.

Item	Description	Length	Width	Quantity	Unit
713-01	Temporary Signs and Barricades: All labor, materials, equipment and supervision necessary to furnish, install, maintain and remove temporary construction barricades, precast concrete barriers, lights, signals, pavement markings and signs, including project signs ; providing flaggers; and complying with all other requirements regarding the protection of the work, workers and safety of the public. Unless otherwise noted in the plans or special provisions this work also includes traffic control management in compliance with contract documents and the Manual on Uniform Traffic Control Devices (MUTCD), including the installation, inspection, maintenance, and removal of all traffic control devices on the project. This item shall not be construed to relieve the contractor of responsibilities for the safety of the public, for liability in connection therewith, or compliance with State and local laws or ordinances. Signs, barricades, barriers, channelizing devices, pavement markings, etc., shall comply with plan details, the MUTCD and Section 713 of LADOTD Standard Specifications for Roads and Bridges, Latest Edition. Construction work shall not begin until signs, barricades, project signs and other traffic devices have been erected and approved.			1	Lump Sum
S-00001	Sawcutting (Concrete): All Labor, Materials, equipment, and supervision necessary to cut full depth concrete road panels. This item is separate and apart from cutting the joints of the road to prevent damaging another panel that is scheduled to remain.			90	IN/FT
715-01-00100	Topsoil Shoulder Material: LA DOTD Standard Specification for Roads and Bridges, Section 401. All labor, materials and equipment necessary to furnish and place Topsoil for shoulder material (Adjusted Vehicular Measurement). Contractor shall place specified shoulder material flush with the asphalt wearing surface course to a maximum of 12" wide. This material shall be graded uniformly throughout the project. Should any excess incidental construction material extend beyond the 12" maximum limit, the material shall be removed and properly disposed of off-site. The finished specified shoulder material shall not consist of any foreign material that is not contained with the parent material.			6	Cubic Yard

All Work Shall Conform to Louisiana Standard Specifications for Roads and Bridges, Latest Edition

Panels will be marked in the field once project is ready to begin.

Item	Description	Length	Width	Quantity	Unit
706-03-00500	<p>Remove/Replace/Repair Concrete Panels: All labor, materials, equipment and supervision necessary to, in accordance with these specifications, and LA DOTD Standard Specifications for Roads and Bridges, Section 706 Latest Edition, Remove/Replace/Repair Concrete Pavement. Contractor shall be responsible for removal of concrete, curbing, and all base materials to a depth of 8" below the bottom grade of the new 8" thick concrete panel. Replacement base material shall be River Sand or Pumped Sand. Base repair and/or patch is not limited to a square yardage quantity, but may include the entire panel if directed by Department of Public Works inspection staff. This item is at no direct pay. Prior to contractor pouring replacement concrete panel and rollover curb, base material shall be examined by project inspector. Contractor shall inspect the project site and bid accordingly. Panels identified for removal and replacement next to and/or adjacent to new panels shall be saw-cut along the adjoining edge. Any damage caused by contractor operations shall be repaired immediately at no direct pay.</p> <p>Replacement panels shall be Fiber reinforced, 4000 psi, 8" thick concrete, with 3/4" smooth dowel bars into existing concrete pavement @ 18" on-center for butt/construction joints. Use #4 deformed bar for longitudinal joints 2' on center. Panels longer than 15' in length shall be split into two panels by means of keyway and load transfer bars.</p> <p>Joints shall be replaced in-kind, to include but not limited to expansion joints, control joints, etc., and sealed with approved joint sealing material.</p> <p>Broken concrete shall be removed and hauled to an area identified by project inspector at no direct pay.</p>			260	Square Yard

All Work Shall Conform to Louisiana Standard Specifications for Roads and Bridges, Latest Edition

Panels will be marked in the field once project is ready to begin.

Item	Description	Length	Width	Quantity	Unit
706-03-00500-A	<p>Remove/Replace/Repair Concrete Panels (High Early): All labor, materials, equipment and supervision necessary to, in accordance with these specifications, and LA DOTD Standard Specifications for Roads and Bridges, Section 706 Latest Edition, Remove/Replace/Repair Concrete Pavement. Contractor shall be responsible for removal of concrete and all base materials to a depth of 8" below the bottom grade of the new 8" thick concrete panel. Replacement base material shall be River Sand or Pumped Sand. Base repair and/or patch is not limited to a square yardage quantity, but may include the entire panel if directed by Department of Public Works inspection staff. This item is at no direct pay. Prior to contractor pouring replacement concrete panel and rollover curb, base material shall be examined by project inspector. Contractor shall inspect the project site and bid accordingly. Panels identified for removal and replacement next to and/or adjacent to new panels shall be saw-cut along the adjoining edge. Any damage caused by contractor operations shall be repaired immediately at no direct pay.</p> <p>Replacement panels shall be Fiber reinforced, 4000 psi @ 72 Hours, 8" thick concrete, with 3/4" smooth dowel bars into existing concrete pavement @ 18" on-center for butt/construction joints. Use #4 deformed bar for longitudinal joints 2' on center. Panels longer than 15' in length shall be split into two panels by means of keyway and load transfer bars.</p> <p>Joints shall be replaced in-kind, to include but not limited to expansion joints, control joints, etc., and sealed with approved joint sealing material.</p> <p>Broken concrete shall be removed and hauled to an area identified by project inspector at no direct pay.</p>			80	Square Yard

All Work Shall Conform to Louisiana Standard Specifications for Roads and Bridges, Latest Edition

Panels will be marked in the field once project is ready to begin.

Item	Description	Length	Width	Quantity	Unit
	<p>General Notes:</p> <ol style="list-style-type: none"> 1. Contractor shall field verify all quantities and measurements. 2. Contractor shall be responsible for locating and protecting all existing utilities. 3. Two-way traffic shall be maintained at all times during construction. Contractor shall have flagmen on both ends of work zone. If Police details are used for traffic control this does not take the place of flag men. 4. Construction work shall not begin until signs, barricades, project signs and other traffic devices have been erected and approved. Contractor shall maintain project and construction signs. 5. All existing sewer lines shall be tied-in at no direct pay. 6. Asphalt and concrete driveway tie-ins shall be tied in to existing surface material. 7. Any additional work performed by the contractor without prior written approval from St Tammany Parish Department of Engineering, the cost of the work will be borne by the contractor and will not be reimbursed by the Parish. 8. Contractor shall ensure roadway and shoulders drain accordingly without any surface ponding/"bird baths" after rain events. 9. Materials Testing: All required testing and reporting shall be the contractor's responsibility at no direct pay. Sampling and Testing will be performed in accordance with the St. Tammany Parish Roadway Testing and Inspection Standards for Residential Subdivisions (Attached with Bid Proposal) and LADOTD Standard Specifications for Roads and Bridges, Latest Edition, Section 101 and 106. 10. Roads and surrounding areas shall be dressed after 7 calendar days and no later than 10 calendar days after opening of street. Late Fee of \$1.00 per Linear Foot per Calendar Day shall be charged if not completed with the specified time frame. 11. If any driveways are impacted, contractor shall give resident 24 hour notice that they need to move vehicles so as to not get blocked in and that they will not be able to access the driveway for three days after pouring concrete. 				
	<p>Project Summary: Contractor shall provide all labor, materials, equipment and supervision necessary to Remove, Replace and/or Repair Concrete Panels and Concrete Rollover/Barrier Curbs.</p>				
727-01	<p>Mobilization: All labor and materials necessary to accomplish preparatory work and operations, including those necessary for movement of personnel, equipment, supplies and incidentals to the project site.</p>			1	Lump Sum

All Work Shall Conform to Louisiana Standard Specifications for Roads and Bridges, Latest Edition

Panels will be marked in the field once project is ready to begin.

Item	Description	Length	Width	Quantity	Unit
713-01	Temporary Signs and Barricades: All labor, materials, equipment and supervision necessary to furnish, install, maintain and remove temporary construction barricades, precast concrete barriers, lights, signals, pavement markings and signs, including project signs ; providing flaggers; and complying with all other requirements regarding the protection of the work, workers and safety of the public. Unless otherwise noted in the plans or special provisions this work also includes traffic control management in compliance with contract documents and the Manual on Uniform Traffic Control Devices (MUTCD), including the installation, inspection, maintenance, and removal of all traffic control devices on the project. This item shall not be construed to relieve the contractor of responsibilities for the safety of the public, for liability in connection therewith, or compliance with State and local laws or ordinances. Signs, barricades, barriers, channelizing devices, pavement markings, etc., shall comply with plan details, the MUTCD and Section 713 of LADOTD Standard Specifications for Roads and Bridges, Latest Edition. Construction work shall not begin until signs, barricades, project signs and other traffic devices have been erected and approved.			1	Lump Sum
S-00001	Sawcutting (Concrete): All Labor, Materials, equipment, and supervision necessary to cut full depth concrete road panels. This item is separate and apart from cutting the joints of the road to prevent damaging another panel that is scheduled to remain.			200	IN/FT
715-01-00100	Topsoil Shoulder Material: LA DOTD Standard Specification for Roads and Bridges, Section 401. All labor, materials and equipment necessary to furnish and place Topsoil for shoulder material (Adjusted Vehicular Measurement). Contractor shall place specified shoulder material flush with the asphalt wearing surface course to a maximum of 12" wide. This material shall be graded uniformly throughout the project. Should any excess incidental construction material extend beyond the 12" maximum limit, the material shall be removed and properly disposed of off-site. The finished specified shoulder material shall not consist of any foreign material that is not contained with the parent material.			12	Cubic Yard

All Work Shall Conform to Louisiana Standard Specifications for Roads and Bridges, Latest Edition

Panels will be marked in the field once project is ready to begin.

Item	Description	Length	Width	Quantity	Unit
<p>706-03-00500</p>	<p>Remove/Replace/Repair Concrete Panels: All labor, materials, equipment and supervision necessary to, in accordance with these specifications, and LA DOTD Standard Specifications for Roads and Bridges, Section 706 Latest Edition, Remove/Replace/Repair Concrete Pavement. Contractor shall be responsible for removal of concrete, curbing, and all base materials to a depth of 8" below the bottom grade of the new 8" thick concrete panel. Replacement base material shall be River Sand or Pumped Sand. Base repair and/or patch is not limited to a square yardage quantity, but may include the entire panel if directed by Department of Public Works inspection staff. This item is at no direct pay. Prior to contractor pouring replacement concrete panel and rollover curb, base material shall be examined by project inspector. Contractor shall inspect the project site and bid accordingly. Panels identified for removal and replacement next to and/or adjacent to new panels shall be saw-cut along the adjoining edge. Any damage caused by contractor operations shall be repaired immediately at no direct pay.</p> <p>Replacement panels shall be Fiber reinforced, 4000 psi, 8" thick concrete, with 3/4" smooth dowel bars into existing concrete pavement @ 18" on-center for butt/construction joints. Use #4 deformed bar for longitudinal joints 2' on center. Panels longer than 15' in length shall be split into two panels by means of keyway and load transfer bars.</p> <p>Joints shall be replaced in-kind, to include but not limited to expansion joints, control joints, etc., and sealed with approved joint sealing material.</p> <p>Broken concrete shall be removed and hauled to an area identified by project inspector at no direct pay.</p>			<p>550</p>	<p>Square Yard</p>

All Work Shall Conform to Louisiana Standard Specifications for Roads and Bridges, Latest Edition

Panels will be marked in the field once project is ready to begin.

Item	Description	Length	Width	Quantity	Unit
706-03-00500-A	<p>Remove/Replace/Repair Concrete Panels (High Early): All labor, materials, equipment and supervision necessary to, in accordance with these specifications, and LA DOTD Standard Specifications for Roads and Bridges, Section 706 Latest Edition, Remove/Replace/Repair Concrete Pavement. Contractor shall be responsible for removal of concrete and all base materials to a depth of 8" below the bottom grade of the new 8" thick concrete panel. Replacement base material shall be River Sand or Pumped Sand. Base repair and/or patch is not limited to a square yardage quantity, but may include the entire panel if directed by Department of Public Works inspection staff. This item is at no direct pay. Prior to contractor pouring replacement concrete panel and rollover curb, base material shall be examined by project inspector. Contractor shall inspect the project site and bid accordingly. Panels identified for removal and replacement next to and/or adjacent to new panels shall be saw-cut along the adjoining edge. Any damage caused by contractor operations shall be repaired immediately at no direct pay.</p> <p>Replacement panels shall be Fiber reinforced, 4000 psi @ 72 Hours, 8" thick concrete, with 3/4" smooth dowel bars into existing concrete pavement @ 18" on-center for butt/construction joints. Use #4 deformed bar for longitudinal joints 2' on center. Panels longer than 15' in length shall be split into two panels by means of keyway and load transfer bars.</p> <p>Joints shall be replaced in-kind, to include but not limited to expansion joints, control joints, etc., and sealed with approved joint sealing material.</p> <p>Broken concrete shall be removed and hauled to an area identified by project inspector at no direct pay.</p>			132	Square Yard

All Work Shall Conform to Louisiana Standard Specifications for Roads and Bridges, Latest Edition

Section 04

LOUISIANA UNIFORM PUBLIC WORK BID FORM

TO: St. Tammany Parish Government
21454 Koop Dr., Suite 2F
Mandeville, La 70471

(Owner to provide name and address of owner)

BID FOR: 2021 District Concrete Panel Replacements

Bid #21-23-2

(Owner to provide name of project and other identifying information.)

The undersigned bidder hereby declares and represents that she/he; a) has carefully examined and understands the Bidding Documents, b) has not received, relied on, or based his bid on any verbal instructions contrary to the Bidding Documents or any addenda, c) has personally inspected and is familiar with the project site, and hereby proposes to provide all labor, materials, tools, appliances and facilities as required to perform, in a workmanlike manner, all work and services for the construction and completion of the referenced project, all in strict accordance with the Bidding Documents prepared by:

St. Tammany Parish Government and dated: April 14, 2021
(Owner to provide name of entity preparing bidding documents.)

Bidders must acknowledge all addenda. The Bidder acknowledges receipt of the following ADDENDA: (Enter the number the Designer has assigned to each of the addenda that the Bidder is acknowledging)

TOTAL BASE BID: For all work required by the Bidding Documents (including any and all unit prices designated "Base Bid" * but not alternates) the sum of:

Dollars (\$)

ALTERNATES: For any and all work required by the Bidding Documents for Alternates including any and all unit prices designated as alternates in the unit price description.

Alternate No. 1 (Owner to provide description of alternate and state whether add or deduct) for the lump sum of:

N/A Dollars (\$)

Alternate No. 2 (Owner to provide description of alternate and state whether add or deduct) for the lump sum of:

N/A Dollars (\$)

Alternate No. 3 (Owner to provide description of alternate and state whether add or deduct) for the lump sum of:

N/A Dollars (\$)

NAME OF BIDDER:

ADDRESS OF BIDDER:

LOUISIANA CONTRACTOR'S LICENSE NUMBER:

NAME OF AUTHORIZED SIGNATORY OF BIDDER:

TITLE OF AUTHORIZED SIGNATORY OF BIDDER:

SIGNATURE OF AUTHORIZED SIGNATORY OF BIDDER **:

DATE:

THE FOLLOWING ITEMS ARE TO BE INCLUDED WITH THE SUBMISSION OF THIS LOUISIANA UNIFORM PUBLIC WORK BID FORM:

* The Unit Price Form shall be used if the contract includes unit prices. Otherwise it is not required and need not be included with the form. The number of unit prices that may be included is not limited and additional sheets may be included if needed.

** A CORPORATE RESOLUTION OR WRITTEN EVIDENCE of the authority of the person signing the bid for the public work as prescribed by LA R.S. 38:2212(B)(5).

BID SECURITY in the form of a bid bond, certified check or cashier's check as prescribed by LA R.S. 38:2218(A) attached to and made a part of this bid.

LOUISIANA UNIFORM PUBLIC WORK BID FORM UNIT PRICE FORM

TO:

St. Tammany Parish Government

21454 Koop Drive, Suite 2F

Mandeville, LA. 70471

(OWNER TO PROVIDE NAME AND ADDRESS OF OWNER)

BID FOR:

2021 District Concrete Panel Replacements

Bid #21-23-2

(OWNER TO PROVIDE PROJECT NAME & OTHER IDENTIFYING INFO)

UNIT PRICES: This form shall be used for any & all work required by the Bidding Documents & described as unit prices. Amounts shall be stated in figures & only in figures.

Description: <input checked="" type="checkbox"/> BASE BID OR <input type="checkbox"/> ALT # Mobilization				
REF NO.:	QUANTITY	UNIT OF MEASURE	UNIT PRICE	UNIT PRICE EXTENSION (Quantity times unit price)
727-01	1	Lump Sum		
Description: <input checked="" type="checkbox"/> BASE BID OR <input type="checkbox"/> ALT # Temporary Signs and Barricades				
REF NO.:	QUANTITY	UNIT OF MEASURE	UNIT PRICE	UNIT PRICE EXTENSION (Quantity times unit price)
713-01	1	Lump Sum		
Description: <input checked="" type="checkbox"/> BASE BID OR <input type="checkbox"/> ALT # Remove/Replace/Repair Concrete Panels				
REF NO.:	QUANTITY	UNIT OF MEASURE	UNIT PRICE	UNIT PRICE EXTENSION (Quantity times unit price)
706-03-00500	4,721	Square Yard		
Description: <input checked="" type="checkbox"/> BASE BID OR <input type="checkbox"/> ALT # Remove/Replace/Repair Concrete Panels (High Early)				
REF NO.:	QUANTITY	UNIT OF MEASURE	UNIT PRICE	UNIT PRICE EXTENSION (Quantity times unit price)
706-03-00500-A	1,411	Square Yard		

Wording for "description" is to be provided by the Owner. All Quantities Estimated. The Contractor will be paid based upon actual quantities as verified by the Owner.

UNIT PRICES: This form shall be used for any & all work required by the Bidding Documents & described as unit prices. Amounts shall be stated in figures & only in figures.

Description: <input checked="" type="checkbox"/> BASE BID OR <input type="checkbox"/> ALT # Sawcutting (Concrete)				
REF NO.:	QUANTITY	UNIT OF MEASURE	UNIT PRICE	UNIT PRICE EXTENSION (Quantity times unit price)
S-00001	2,010	IN/FT		
Description: <input checked="" type="checkbox"/> BASE BID OR <input type="checkbox"/> ALT # Topsoil Shoulder Material				
REF NO.:	QUANTITY	UNIT OF MEASURE	UNIT PRICE	UNIT PRICE EXTENSION (Quantity times unit price)
715-01-00100	84	Cubic Yard		
Description: <input type="checkbox"/> BASE BID OR <input type="checkbox"/> ALT #				
REF NO.:	QUANTITY	UNIT OF MEASURE	UNIT PRICE	UNIT PRICE EXTENSION (Quantity times unit price)
Description: <input type="checkbox"/> BASE BID OR <input type="checkbox"/> ALT #				
REF NO.:	QUANTITY	UNIT OF MEASURE	UNIT PRICE	UNIT PRICE EXTENSION (Quantity times unit price)
Description: <input type="checkbox"/> BASE BID OR <input type="checkbox"/> ALT #				
REF NO.:	QUANTITY	UNIT OF MEASURE	UNIT PRICE	UNIT PRICE EXTENSION (Quantity times unit price)
Description: <input type="checkbox"/> BASE BID OR <input type="checkbox"/> ALT #				
REF NO.:	QUANTITY	UNIT OF MEASURE	UNIT PRICE	UNIT PRICE EXTENSION (Quantity times unit price)

Version 2017 Q2

Wording for "description" is to be provided by the Owner. All Quantities Estimated. The Contractor will be paid based upon actual quantities as verified by the Owner.

Section 05

**AFFIDAVIT PURSUANT TO LSA-R.S. 38:2224 and 38:2227
FOR BIDDERS FOR PUBLIC WORKS CONTRACTS**

STATE OF _____

PARISH/COUNTY OF _____

BEFORE ME, the undersigned authority, in and for the above stated State and Parish (or County), personally came and appeared:

Print Name

who, after first being duly sworn, did depose and state:

1. That affiant is appearing on behalf of _____, who is seeking a public contract with St. Tammany Parish Government.
2. That affiant employed no person, corporation, firm, association, or other organization, either directly or indirectly, to secure the public contract under which he received payment, other than persons regularly employed by the affiant whose services in connection with the construction, alteration or demolition of the public building or project or in securing the public contract were in the regular course of their duties for affiant; and
3. That no part of the contract price received by affiant was paid or will be paid to any person, corporation, firm, association, or other organization for soliciting the contract, other than the payment of their normal compensation to persons regularly employed by the affiant whose services in connection with the construction, alteration or demolition of the public building or project were in the regular course of their duties for affiant.
4. If affiant is a sole proprietor, that after July 2, 2010, he/she has not been convicted of, or has not entered a plea of guilty or *nolo contendere* to any of the crimes or equivalent federal crimes listed in LSA-R.S. 38:2227(B).
5. If affiant is executing this affidavit on behalf of a juridical entity such as a partnership, corporation, or LLC, etc., that no individual partner, incorporator, director, manager, officer, organizer, or member, who has a minimum of a ten percent ownership in the bidding entity, has been convicted of, or has entered a plea of guilty or *nolo contendere* to any

of the crimes or equivalent federal crimes listed in LSA-R.S. 38:2227(B).

6. If affiant is a sole proprietor, that neither affiant, nor his/her immediate family is a public servant of St. Tammany Parish Government or the Contract is not under the supervision or jurisdiction of the public servant's agency.

7. If affiant is executing this affidavit on behalf of a juridical entity such as a partnership, corporation, or LLC, etc., that no public servant of St. Tammany Parish Government, or his/her immediate family, either individually or collectively, has more than a 25% ownership interest in the entity seeking the Contract with St. Tammany Parish Government if the Contract will be under the supervision or jurisdiction of the public servant's agency.

Printed Name: _____
Title: _____
Entity name: _____

THUS SWORN TO AND SUBSCRIBED BEFORE ME,
THIS _____, DAY OF _____, 202__.

Notary Public
Print Name: _____
Notary I.D./Bar No.: _____
My commission expires: _____

**AFFIDAVIT PURSUANT TO LSA-R.S. 38:2212.10 CONFIRMING
REGISTRATION AND PARTICIPATION IN A STATUS VERIFICATION
SYSTEM**

STATE OF _____

PARISH/COUNTY OF _____

BEFORE ME, the undersigned authority, in and for the above stated State and Parish (or County), personally came and appeared:

Print Name

who, after first being duly sworn, did depose and state:

1. That affiant is appearing on behalf of _____, a private employer seeking a bid or a contract with St. Tammany Parish Government for the physical performance of services within the State of Louisiana.

2. That affiant is registered and participates in a status verification system to verify that all employees in the state of Louisiana are legal citizens of the United States or are legal aliens; and

3. That affiant shall continue, during the term of the contract, to utilize a status verification system to verify the legal status of all new employees in the state of Louisiana.

4. That affiant shall require all subcontractors to submit to the affiant a sworn affidavit verifying compliance with this law.

Printed Name: _____
Title: _____
Name of Entity: _____

**THUS SWORN TO AND SUBSCRIBED BEFORE ME,
THIS _____, DAY OF _____, 202__.**

Notary Public
Print Name: _____
Notary I.D./Bar No.: _____
My commission expires: _____



Section 06

INSURANCE REQUIREMENTS*

Construction Project: 2021 District Concrete Panel Replacements

Bid#: 21-23-2

*****IMPORTANT – PLEASE READ*****

Prior to submitting your quote or bid, it is recommended that you review these insurance requirements with your insurance broker/agent.

These requirements modify portions of the insurance language found in the General Conditions and/or Supplementary General Conditions; however, there is no intention to remove all sections pertaining to insurance requirements and limits set forth in the General Conditions and/or Supplementary General Conditions, only to amend and specify those items particular for this Project.

- A. The Provider shall secure and maintain at its expense such insurance that will protect it and St. Tammany Parish Government (the "Parish") from claims for bodily injury, death or property damage as well as from claims under the Workers' Compensation Acts that may arise from the performance of services under this agreement. All certificates of insurance shall be furnished to the Parish and provide thirty (30) days prior notice of cancellation to the Parish, in writing, on all of the required coverage.
- B. All policies shall provide for and certificates of insurance shall indicate the following:
1. Waiver of Subrogation: The Provider's insurers will have no right of recovery or subrogation against the Parish of St. Tammany, it being the intention of the parties that all insurance policy(ies) so affected shall protect both parties and be the primary coverage for any and all losses covered by the below described insurance.
 2. Additional Insured: St. Tammany Parish Government shall be named as Additional Insured with respect to general liability, automobile liability and excess liability coverages, as well as marine liability and pollution/environmental liability, when those coverages are required or necessary.
 3. Payment of Premiums: The insurance companies issuing the policy or policies will have no recourse against St. Tammany Parish Government for payment of any premiums or for assessments under any form of policy.
 4. Deductibles/Self-Insured Retentions: Any deductibles and/or self-insured retentions in the described insurance policies **must be declared on the Certificate of Insurance**, and are both assumed by and the sole risk of the Provider. The Parish will have the sole discretion to accept or reject deductibles and/or self-insured retentions exceeding \$100,000 as it deems appropriate. The Parish may require Provider to produce evidence of verifiable financial ability to satisfy its deductibles and/or self-insured retentions; however, the Parish assumes no liability or obligation resulting from its examination, acceptance, or rejection of information presented.
 5. Project Reference: The project(s) and location(s) shall be referenced in the Comment or Description of Operations section of the Certificate of Insurance (Project ##-###, or Bid # if applicable, Type of Work, Location).
- C. Coverage must be issued by insurance companies authorized to do business in the State of Louisiana. Companies must have an A.M. Best rating of no less than A-, Category VII. St. Tammany Parish Risk Management Department may waive this requirement only for Workers Compensation coverage at their discretion.

Provider shall secure and present proof of insurance on forms acceptable to St. Tammany Parish Government, Office of Risk Management no later than the time of submission of the Contract to the Parish. However, should any work performed under this Contract by or on behalf of Provider include exposures that are not covered by those insurance coverages, Provider is not relieved of its obligation to maintain appropriate levels and types of insurance necessary to protect itself, its agents and employees, its subcontractors, St. Tammany Parish Government (Owner), and all other interested third parties, from any and all claims for damage or injury in connection with the services performed or provided throughout the duration of this Project, as well as for any subsequent periods required under this Contract.

The insurance coverages checked (✓) below are those required for this Contract.

- 1. **Commercial General Liability*** insurance – **Occurrence Form** - with a Combined Single Limit for bodily injury and property damage of at least \$1,000,000 per Occurrence / \$2,000,000 General Aggregate and \$2,000,000 Products-Completed Operations. Contracts over \$1,000,000 may require higher limits. The insurance shall provide for and the certificate(s) of insurance shall indicate the following coverages:
 - a) Premises - operations;
 - b) Broad form contractual liability;
 - c) Products and completed operations;
 - d) Personal/Advertising Injury;
 - e) Broad form property damage (for Projects involving work on Parish property);
 - f) Explosion, Collapse and Damage to underground property.
 - g) Additional Insured forms CG 2010 and CG 2037 in most current edition are required.

- 2. **Business Automobile Liability*** insurance with a Combined Single Limit of \$1,000,000 per Occurrence for bodily injury and property damage, and shall include coverage for the following:
 - a) Any auto;
 - or**
 - b) Owned autos; **and**
 - c) Hired autos; **and**
 - d) Non-owned autos.

- 3. **Workers' Compensation/Employers Liability insurance*** - Workers' Compensation coverage as required by State law. Employers' liability limits shall be a minimum of \$1,000,000 each accident, \$1,000,000 each disease, \$1,000,000 disease policy aggregate. When water activities are expected to be performed in connection with this project, coverage under the USL&H Act, Jones Act and/or Maritime Employers Liability (MEL) must be included. **Coverage for owners, officers and/or partners in any way engaged in the Project shall be included in the policy.** The names of any excluded individual must be shown in the Description of Operations/Comments section of the Certificate.

- 4. **Pollution Liability and Environmental Liability*** insurance in the minimum amount of \$1,000,000 per occurrence / \$2,000,000 aggregate including full contractual liability and third party claims for bodily injury and/or property damage, for all such hazardous waste, pollutants and/or environmental exposures that may be affected by this project stemming from pollution/environmental incidents as a result of Contractor's operations.

If coverage is provided on a claims-made basis, the following conditions apply:

- 1) the retroactive date must be prior to or coinciding with the effective date of the Contract, or prior to the commencement of any services provided by the Contractor on behalf of the Parish, whichever is earlier; AND
- 2) continuous coverage must be provided to the Parish with the same retro date for 24 months following acceptance or termination of the Project by the Parish either by
 - a) continued renewal certificates **OR**
 - b) a 24 month Extended Reporting Period

*The Certificate must indicate whether the policy is written on an occurrence or claims-made basis and, if claims-made, the applicable retro date must be stated.

5. **Contractor's Professional Liability/Errors and Omissions*** insurance in the sum of at least \$1,000,000 per claim / \$2,000,000 aggregate is required when work performed by Contractor or on behalf of Contractor includes professional or technical services including, but not limited to, construction administration and/or management, engineering services such as design, surveying, and/or inspection, technical services such as testing and laboratory analysis, and/or environmental assessments. An occurrence basis policy is preferred.

If coverage is provided on a claims-made basis, the following conditions apply:

- 1) the retroactive date must be prior to or coinciding with the effective date of the Contract, or prior to the commencement of any services provided by the Contractor on behalf of the Parish, whichever is earlier; AND
- 2) continuous coverage must be provided to the Parish with the same retro date for 24 months following acceptance or termination of the Project by the Parish either by
 - a) continued renewal certificates **OR**
 - b) a 24 month Extended Reporting Period

*The Certificate must indicate whether the policy is written on an occurrence or claims-made basis and, if claims-made, the applicable retro date must be stated.

6. **Marine Liability/Protection and Indemnity*** insurance is required for any and all vessel and/or marine operations in the minimum limits of \$1,000,000 per occurrence / \$2,000,000 per project general aggregate. The coverage shall include, but is not limited to, the basic coverages found in the Commercial General Liability insurance and coverage for third party liability

***Excess/Umbrella Liability** insurance may be provided to meet the limit requirements for any Liability coverage. For example: if the General Liability requirement is \$3,000,000 per occurrence, but the policy is only \$1,000,000 per occurrence, then the excess policy should be at least \$2,000,000 per occurrence thereby providing a combined per occurrence limit of \$3,000,000.)

7. **Owners Protective Liability (OPL)** shall be furnished by the Contractor and shall provide coverage in the minimum amount of \$1,000,000 CSL each occurrence / \$1,000,000 aggregate. **St. Tammany Parish Government, ATTN: Risk Management Department, P. O. Box 628, Covington, LA 70434 shall be the first named insured on the policy.**

8. **Builder's Risk Insurance** written on an "all-risk" policy form shall be furnished by Contractor for 100% of the contract cost. Any contract modifications increasing the contract cost will require an increase in the limit of the Builder's Risk policy. Deductibles should not exceed \$5,000 and Contractor shall be responsible for all policy deductibles. This insurance shall cover materials at the site, stored off the site, and in transit. The Builder's Risk Insurance shall include the interests of the Owner, Contractor and Subcontractors and shall terminate only when the Project is accepted in writing. **St. Tammany Parish Government, ATTN: Risk Management Department, P. O. Box 628, Covington, LA 70434 shall be the first named insured on the policy.**

9. **Installation Floater Insurance**, on an "all-risk" form, shall be furnished by Contractor and carried for the full value of the materials, machinery, equipment and labor for each location. The Contractor shall be responsible for all policy deductibles. The Installation Floater Insurance shall provide coverage for property owned by others and include the interests of the Owner, Contractor and Subcontractors and shall terminate only when the Project is accepted in writing. **St. Tammany Parish Government, ATTN: Risk Management Department, P. O. Box 628, Covington, LA 70434 shall be the first named insured on the policy.**

- D. All policies of insurance shall meet the requirements of the Parish prior to the commencing of any work. The Parish has the right, but not the duty, to approve all insurance coverages prior to commencement of work. If any of the required policies are or become unsatisfactory to the Parish as to form or substance; or if a company issuing any policy is or becomes unsatisfactory to the Parish, the Provider shall promptly obtain a new policy, timely submit same to the Parish for approval, and submit a certificate thereof as provided above. The Parish agrees not to unreasonably withhold approval of any insurance carrier selected by Provider. In the event that Parish cannot agree or otherwise authorize a carrier, Provider shall have the option of selecting and submitting a new insurance carrier within 30 days of said notice by the Parish. In the event that the second submission is insufficient or is not approved, then the Parish shall have the unilateral opportunity to thereafter select a responsive and responsible insurance carrier all at the cost of Provider and thereafter deduct from Provider's fee the cost of such insurance.
- E. Upon failure of Provider to furnish, deliver and/or maintain such insurance as above provided, this contract, at the election of the Parish, may be declared suspended, discontinued or terminated. Failure of the Provider to maintain insurance shall not relieve the Provider from any liability under the contract, nor shall the insurance requirements be construed to conflict with the obligation of the Provider concerning indemnification.
- F. Provider shall maintain a current copy of all annual insurance policies and agrees to provide a certificate of insurance to the Parish on an annual basis or as may be reasonably requested for the term of the contract or any required Extended Reporting Period. Provider further shall ensure that all insurance policies are maintained in full force and effect throughout the duration of the Project and shall provide the Parish with annual renewal certificates of insurance evidencing continued coverage, without any prompting by the Parish.
- G. It shall be the responsibility of Provider to require that these insurance requirements are met by all contractors and sub-contractors performing work for and on behalf of Provider. Provider shall further ensure the Parish is named as an additional insured on all insurance policies provided by said contractor and/or sub-contractor throughout the duration of the project.
- H. Certificates of Insurance shall be issued as follows:

**St. Tammany Parish Government
Attn: Risk Management
P O Box 628
Covington, LA 70434**

To avoid contract processing delays, be certain the project name/number is included on all correspondence including Certificates of Insurance.

***NOTICE: St. Tammany Parish Government reserves the rights to remove, replace, make additions to and/or modify any and all of the insurance requirements at any time.**

Any inquiry regarding these insurance requirements should be addressed to:

**St. Tammany Parish Government
Office of Risk Management
P O Box 628
Covington, LA 70434
Telephone: 985-898-2797
Fax: 985-898-3070
Email: riskman@stpgov.org**

HOLD HARMLESS AGREEMENT

_____ (Contractor) agrees to protect, defend, indemnify, save, and hold harmless St. Tammany Parish Government, its elected and appointed officials, departments, agencies, boards and commissions, its officers, agents servants, employees, including volunteers, from and against any and all claims, demands, expense and liability arising out of injury or death to any person or the damage, loss or destruction of any property to the extent caused by any act or omission of Contractor, its agents, servants, employees, and subcontractors, or any and all costs, expense and/or attorney fees incurred as a result of any claim, demands, and/or causes of action that results under the performance or non-performance of this contract.

_____ (Contractor) agrees to investigate, handle, respond to, provide defense for and defend any such claims, demand, or suit, as described in the paragraph above, at its sole expense and agrees to bear all other costs and expenses related thereto, even if it (claims, etc.) is groundless, false or fraudulent.

SIGNED, this ____ day of _____, 20__

WITNESSES:

Print Name: _____

Print Name: _____

BY: _____
(Signature of Authorized Officer)

Print Name: : _____

Title: _____

STATE OF _____

PARISH/COUNTY OF _____

SWORN TO and subscribed before me, Notary, on this ____ day of _____, 20__.

NOTARY PUBLIC

My Commission Expires: _____

Please complete the following:

Claims contact for this project will be:

(Print name and title of Contact Person)

Address

Email address

Telephone#

Cell #

Fax #

Section 07

Project Signs

1. General

- a. Work to include providing and installing project sign(s) at the beginning of the project. Some projects may require multiple signs. Should more than one sign be required, it will be reflected in the bidding documents.

2. Materials

- a. The printed project sign(s) shall be 3/8" primed Medium Density Overlay (MDO) **OR** 3 millimeter corrugated plastic secured to exterior plywood (4' x 4').
- b. Contractor shall not use previously provided templates and/or fonts.

3. Execution

- a. The sign(s) shall be printed on a project-by-project basis in black and white, using the template and font provided to the Contractor by the St. Tammany Parish Government Project Manager.
- b. All signage proofed and approved by State Tammany Parish Government before project sign(s) are to be produced by the Contractor.
- c. Exact placement of the project sign(s) must be coordinated with, and approved by, the St. Tammany Parish Government Project Manager prior to sign installation.
- d. The sign(s) is to be installed such that the bottom of the sign is a minimum of 5' above the existing ground elevation.
- e. Sign(s) is to be maintained throughout the period of construction. If sign(s) is damaged or destroyed, repair and/or replacement of sign(s) will be at Contractor's expense.
- f. Contractor is responsible for the removal of all project signs upon issuance of final acceptance by the St. Tammany Parish Government Project Manager at no direct pay.
- g. Cost to be included in "Temporary Signs and Barricades

Blank Template of Parish Project Sign:

PROGRESS



MICHAEL B. COOPER
Parish President

Councilmember Name
Council District X

\$XXX,XXX.XX

Total Dollar \$
amount specified here

Project Name

Description of
Project Work

Name of Street, Bridge,
Subdivision, etc. stated here

Short Description of Project stated here
(if deemed applicable by the Parish)

Example of a Completed Parish Project Sign:

PROGRESS



MICHAEL B. COOPER
Parish President

RYKERT O. TOLEDANO, JR
Council District 5

\$514,444.40

**Dove Park
Subdivision Drainage**
Drainage Improvements along
Swallow St., Sparrow St.,
Partridge St. and Egret St.

Section 08

General Conditions for St. Tammany Parish Government

This index is for illustrative purposes only and is not intended to be complete nor exhaustive.

All bidders/contractors are presumed to have read and understood the entire document. Some information contained in these conditions may not be applicable to all projects.

GENERAL CONDITIONS INDEX

A.A.S.H.T.O	01.01
A.C.I.	01.02
ADDENDA	01.03, 01.05, 01.12, 02.13, 02.13, 06.02, 06.03
ADVERTISEMENT	01.04, 01.12, 02.21, 02.22, 02.23
AGREEMENT	01.05, 01.11, 01.12, 01.14, 01.15, 01.19, 03.02, 03.03, 03.04, 06.01, 06.02, 10.01, 11.03, 12.01, 14.02, 29.06, 32.01, 32.02, 33.06, 33.07
APPLICATION FOR PAYMENT	01.06, 29.07
A.S.T.M.	01.07
AWARD	03.00, 03.01, 03.04, 03.05
BID	01.08, 01.12, 01.26, 02.02, 02.04, 02.08, 02.09, 02.10, 02.13, 02.14, 02.17, 02.19, 02.21, 03.01, 03.04, 04.02, 14.03, 22.01, 23.01, 28.08
BIDDER	01.04, 01.08, 01.09, 01.26, 01.28, 02.02, 02.04, 02.06, 02.08, 02.09, 02.10, 02.12, 03.13, 02.14, 02.16, 02.17, 02.19, 02.20, 02.21, 02.24, 03.01, 03.04, 03.05, 23.01
BONDS	01.10, 01.12, 02.02, 02.09, 03.00, 03.03, 03.04, 03.05, 03.07, 03.08, 03.10, 03.12, 03.13, 27.06
CHANGE ORDER	01.11, 01.19, 04.01, 09.04, 11.07, 16.02, 16.06, 16.07, 21.06, 21.08, 21.10, 21.11, 29.06, 33.07
CLAIMS	02.15, 04.05, 09.05, 14.01, 16.04, 16.05, 21.16, 24.01
CLOSING ROADS COMMENCE WORK	16.06, 16.07, 16.15 04.04, 07.04, 09.02, 11.02, 14.02, 16.13, 24.02
COMPLETION OF WORK OR PROJECT	01.14, 02.15, 08.03, 09.01, 09.04, 11.00, 11.03, 12.01, 13.01, 13.11, 20.01, 25.01, 28.02, 29.04
CONDITIONS AT JOB SITE	16.17
CONTRACT DOCUMENTS	01.03, 01.03, 01.10, 01.12, 01.13, 01.16, 01.17, 01.18, 01.19, 01.29, 01.22, 01.25, 01.30, 01.33, 02.02, 02.05, 02.13, 02.17, 02.18, 02.23, 03.01, 03.02, 04.01, 04.02, 04.03, 04.04, 04.05, 06.00, 06.01, 06.02, 06.03, 07.02, 07.03, 07.05, 08.01, 10.06, 11.03, 13.01, 13.02, 21.01, 21.09, 21.10, 21.11, 28.01, 28.04, 33.01
CONTRACT PRICE	01.11, 01.13, 03.05, 04.01, 12.01, 14.02, 21.06, 21.10, 21.11, 27.05, 28.01, 28.02, 28.03, 28.08

CONTRACT TIME	01.11, 01.14, 01.22, 10.06, 11.01, 21.06, 29.04
CONTRACTOR - (Defined)	01.15
DAMAGE	02.15, 03.05, 03.12, 04.05, 09.05, 11.09, 13.11, 14.01, 14.02, 16.01, 16.02, 16.03, 16.04, 16.05, 19.01, 19.03, 20.01, 20.08, 23.03, 24.01, 24.07, 24.12, 26.03, 28.05, 28.01, 28.10, 33.07
DEFECTIVE WORK	01.16, 10.03, 21.00, 21.01, 21.07, 21.08, 21.09, 21.10, 28.03
DELAYS	07.02, 11.05, 11.09, 12.01, 16.07, 18.02, 19.01, 28.04
DRAWINGS	01.12, 01.17, 02.13, 02.17, 02.23, 06.01, 06.02, 06.03, 13.15, 22.02, 01.27, 01.33, 03.12, 04.01, 06.02, 09.01, 10.01, 10.02, 11.07, 13.00, 13.01, 13.03, 13.05, 13.11, 13.12, 13.15, 14.02, 14.07, 14.08, 14.09, 16.09, 16.13, 21.01, 21.06, 21.07, 21.14, 24.07, 27.05, 27.07, 28.01, 28.05, 28.10, 29.03, 13.00, 13.11
ENGINEER STATUS (NOT APPLICABLE)	15.00
EXTRA WORK	03.09, 14.00, 14.03, 14.04, 14.05, 14.08, 14.09, 14.10, 14.11, 14.12, 16.01, 22.02
FAILURE OF CONTRACTOR	03.10, 04.05, 06.02, 09.05, 10.01, 10.03, 13.10, 16.03, 20.01, 24.09, 27.02, 28.10
FAILURE OF OWNER	02.13
FAILURE OF SUCCESSFUL BIDDER	02.13, 02.17, 03.04
FIELD ORDER	01.18
FORCE ACCOUNT	14.04, 14.05, 14.11, 14.12
FUNDING	33.09
INDEMNIFY / HOLD HARMLESS	02.15, 03.05, 04.05, 13.11, 16.04, 16.05, 20.02, 24.06, 24.09
INDEMNIFYING INFRINGEMENT CLAUSE	02.15
INJURIES	16.00, 16.01, 16.02, 19.01, 19.03, 20.01, 24.02, 24.07
INSPECTION FEES	13.12
INSPECTIONS, GENERALLY	01.16, 13.05, 16.13, 21.00, 21.03, 21.04, 21.05, 21.06, 21.14, 21.15, 28.04, 29.02, 29.03
INSURANCE	01.05, 14.05, 16.13, 24.00 - 12, 27.07, 28.05
INTENTION OF CONTRACT DOCUMENTS	06.00, 06.01
INTENTION OF GENERAL CONDITIONS	31.00

LABOR	01.33, 03.12, 09.01, 13.00, 13.01, 13.02, 13.08, 13.10, 13.11, 13.12, 14.05, 16.06, 16.07, 21.06, 21.07, 21.15, 27.01, 28.10, 29.03
LAWS	01.10, 01.20, 02.06, 02.13, 02.14, 02.16, 02.20, 03.01, 03.10, 13.12, 16.06, 16.07, 20.02, 21.02, 21.09, 27.01, 29.06, 33.00, 33.01, 33.08
LIQUIDATED DAMAGES	11.03, 12.00, 12.01, 29.04
MATERIALS	01.33, 03.12, 04.01, 06.02, 07.01, 09.01, 10.01, 10.02, 13.00, 13.01, 13.03, 13.04, 13.05, 13.12, 13.13, 13.15, 14.01, 14.11, 20.01, 12.01, 21.07, 21.14, 21.15, 23.03, 27.01, 27.05, 27.07, 28.01, 28.05, 28.07, 28.08, 28.10
MODIFICATIONS	01.12, 01.19, 02.12, 02.13, 06.01, 06.02, 24.07, 32.02
NOTICE OF AWARD	01.20, 03.01, 03.04, 04.01
NOTICE OF DEFAULT	12.01, 33.08
NOTICE TO BIDDER	2.21
NOTICE TO CONTRACTOR	01.12, 01.21, 21.11, 30.01
NOTICE TO OWNER	13.07, 24.06, 27.07
NOTICE TO PROCEED	01.22, 09.02, 11.01, 11.03
OBSTRUCTIONS	16.09, 16.11, 16.15, 23.00, 23.01, 23.02
OCCUPANCY	25.00
ORAL INTERPRETATIONS	02.13
OWNER - (Defined)	01.23
PAYMENT	01.30, 03.10, 03.12, 03.13, 04.12, 09.03, 11.04, 11.09, 14.04, 14.12, 16.02, 16.16, 19.02, 21.07, 21.08, 21.09, 21.10, 21.11, 21.16, 24.02, 24.03, 24.12, 27.01, 27.07, 28.00, 28.01, 28.02, 28.03, 28.04, 28.05, 28.06, 28.08, 28.09, 28.10, 29.00, 29.03, 29.05, 29.07
PERMITS	13.00, 13.12, 16.13, 28.08
PRICE	02.05, 14.02, 14.03, 14.04, 14.05, 22.01
PROGRESS PAYMENT	01.06, 28.06
PROGRESS SCHEDULE	09.03, 09.05, 21.11
PROGRESS OF WORK	09.00, 11.09, 13.07, 16.01, 16.12, 21.11, 21.12, 22.02, 27.02
PROJECT	01.24, 01.29, 01.30, 02.04, 03.07, 06.01, 07.03, 10.02, 11.04, 11.06, 13.08, 13.13, 14.08, 14.11, 16.15, 24.07, 24.11, 28.07, 29.03, 29.07

PROJECT REPRESENTATIVE	01.23, 21.16
PROPERTY	16.00, 16.01, 16.02, 16.03, 16.12, 16.13, 16.17, 18.01, 19.00, 19.01, 19.02, 19.03, 23.03, 24.01, 24.07, 26.03, 28.10, 29.08, 33.05
PROPOSAL	01.26, 02.00, 02.01, 02.03, 02.05, 02.06, 02.07, 02.08, 02.09, 02.10, 02.11, 02.12, 02.14, 02.18, 02.21, 02.22, 11.03, 12.01, 14.01, 14.02, 14.03, 19.02, 23.02, 28.08
PROTESTS	33.10
PUNCH LIST	29.03, 29.04
QUANTITIES OF ESTIMATES	14.00, 14.01, 14.02, 14.04
RAILROADS	16.13, 19.01
RECORD DRAWINGS	08.00, 18.01, 18.02, 18.03
RECORDATION OF DOCUMENTS	03.13, 28.03, 29.05, 29.06
REJECTION OF BIDS	02.03, 02.07, 02.08, 02.10, 02.14, 03.01
RENTAL OF EQUIPMENT	14.07, 14.09
RIGHTS OF WAY	18.00
SAFETY	16.01, 16.07, 16.14, 16.17
SANITARY PROVISIONS	13.01, 17.00
SCHEDULE OF WORK	09.03, 09.04, 9.05, 11.06, 13.09
SEVERABILITY	32.01, 32.02
SHOP DRAWINGS	01.27, 06.03, 07.00, 07.01, 07.02, 07.03, 07.04, 07.05
SITE	02.17, 7.04, 13.05, 13.07, 13.11, 14.06, 16.09, 21.08, 21.09, 21.12, 22.02, 23.01, 24.07
SOLICITATION OF EMPLOYMENT	13.14
SPECIFICATIONS	01.01, 01.02, 01.05, 01.07, 01.12, 01.28, 02.13, 02.17, 02.23, 03.06, 03.09, 03.10, 03.13, 06.01, 06.02, 06.03, 07.04, 07.05, 11.03, 13.05, 13.15, 20.01, 21.12, 22.02, 28.01, 28.04, 32.01
SUBCONTRACTOR	01.27, 01.29, 04.01, 04.02, 04.03, 04.04, 04.05, 16.02, 16.04, 16.05, 20.01, 20.02, 21.07, 24.01, 24.07, 27.01, 28.07
SUBCONTRACTS	04.00, 13.09
SUBSURFACE CONDITIONS	02.17, 22.00, 22.01, 22.02
SUBSTANTIAL COMPLETION	01.30, 11.04, 21.09, 28.04, 29.01, 29.02, 29.03, 29.04, 29.06
SUPERINTENDENT	01.21, 01.31, 13.07, 14.05

SUPERVISION	13.01, 13.06
SURETY	01.05, 01.10, 02.09, 03.05, 03.06, 03.07, 03.08, 03.09, 03.11, 03.12, 04.05, 05.01, 14.03, 27.03, 27.05
SURVEY	13.02, 26.00, 26.01
TAXES	02.05, 13.00, 13.12, 13.13, 14.05, 28.07, 28.08, 28.10
TERMINATION OF CONTRACT	13.10, 24.09, 27.00, 27.01, 27.02, 27.03, 27.04, 27.05, 27.06, 27.07
TESTS, GENERALLY	21.00, 21.02, 21.03, 21.04, 21.05, 21.06
TIME	01.32
TRAFFIC	16.06, 16.07, 16.10, 16.15, 16.16
TRAFFIC HAZARDS	16.16
TREES AND SHRUBS	19.02
VERBAL INSTRUCTIONS	21.16
WAIVERS	24.06, 29.03, 33.08
WARNING DEVICES	16.13, 16.14, 16.15
WARRANTY	21.01, 21.08, 21.09, 33.04, 33.06
WORK	01.31, 20.01
WORK BY OTHERS	10.03, 10.04, 10.05
WORK BY OWNER	10.02, 10.04, 10.05
WORK FOR OTHER, RESTRICTIONS	16.12
WORK ORDER	28.01

01.00 DEFINITIONS OF TERMS

Whenever used in these General Conditions or in other Contract Documents, the following terms shall have the meanings indicated, and these shall be applicable to both the singular and plural thereof.

- 01.01 A.A.S.H.T.O American Association of State Highway and Transportation Officials. When A.A.S.H.T.O. is referred to in these Specifications it takes the meaning of the specification for materials and methods of testing specified by this association and the specification stated is considered to be a part of the Specifications as if written herein in full.
- 01.02 A.C.I American Concrete Institute. When A.C.I. is referred to in these Specifications it takes the meaning of the specification for materials and methods of testing specified by this institute and the specification stated is considered to be a part of the Specifications as if written herein in full.
- 01.03 Addenda Written or graphic instruments issued prior to the opening of bids which clarify, correct, modify or change the bidding or Contract Documents.
- 01.04 Advertisement The written instrument issued by the Owner at the request of the Owner used to notify the prospective bidder of the nature of the Work. It becomes part of the Contract Documents.
- 01.05 Agreement The written agreement or contract between the Owner and the Contractor covering the Work to be performed and the price that the Owner will pay. Other documents, including the Proposal, Addenda, Specifications, plans, surety, insurance, etc., are made a part thereof.
- 01.06 Application for Payment The form furnished by the Owner which is to be used by the Contractor in requesting incremental (progress) payments and which is to include information required by Section 28.01 and an affidavit of the Contractor. The affidavit shall stipulate that progress payments theretofore received from the Owner on account of the Work have been applied by Contractor to discharge in full of all Contractor's obligations reflected in prior applications for payment.
- 01.07 A.S.T.M. American Society of Testing Materials. When A.S.T.M. is referred to in these Specifications it takes the meaning of the specification for materials and methods of testing specified by this society and the specification stated is considered to be a part of the Specifications as if written herein in full.
- 01.08 Bid The offer or Proposal of the Bidder submitted on the prescribed form setting forth all the prices for the Work to be performed.
- 01.09 Bidder Any person, partnership, firm or corporation submitting a Bid for the Work.
- 01.10 Bonds Bid, performance and payment bonds and other instruments of security, furnished by the Contractor and its surety in accordance with the Contract Documents and Louisiana law.
- 01.11 Change Order A written order to the Contractor signed by the Owner authorizing an addition, deletion or revision in the Work, or an adjustment in the Contract Price or the Contract Time after execution of the Agreement.
- 01.12 Contract Documents The Agreement, Addenda, Contractor's Bid and any documentation accompanying or post-bid documentation when attached as an exhibit, the Bonds, these General Conditions, the Advertisement for Bid, Notice to Contractor, all supplementary conditions, the Specifications, the Drawings, together with all Modifications issued after the execution of the Agreement.
- 01.13 Contract Price The total monies payable to the Contractor under the Contract Documents.

- 01.14 Contract Time The number of consecutive calendar days stated in the Agreement for the completion of the Work.
- 01.15 Contractor The person, firm, corporation or provider with whom the Owner has executed the Agreement.
- 01.16 Defective Work Work which is unsatisfactory, faulty or deficient for any reason whatsoever, or does not conform to the Contract Documents, or does not meet the requirements of any inspection, test or approval referred to in the Contract Documents, or has been damaged prior to the Owner's recommendation or acceptance.
- 01.17 Drawings The Drawings and plans which show the character and scope of the Work to be performed and which have been prepared or approved by the Owner and are referred to in the Contract Documents.
- 01.18 Field Order A written order issued by the Owner or his agent which clarifies or interprets the Contract Documents.
- 01.19 Modification (a) A written amendment of the Contract Documents signed by both parties, (b) A Change Order, (c) A written clarification or interpretation issued by the Owner or his agent. Modification may only be issued after execution of the Agreement.
- 01.20 Notice of Award The written notice by Owner to the lowest responsible Bidder stating that upon compliance of the conditions enumerated in the Notice of Award, or enumerated in the Bid documents, the Owner will deliver the Contract Documents for signature. The time for the delivery of the Contract Documents can be extended in conformance with Louisiana Law.
- 01.21 Notice to Contractor Instructions, written or oral given by Owner to Contractor and deemed served if given to the Contractor's superintendent, foreman or mailed to Contractor at his last known place of business.
- 01.22 Notice to Proceed A written notice given by the Owner fixing the date on which the Contract Time will commence, and on which date the Contractor shall start to perform his obligation under the Contract Documents. Upon mutual consent by both parties, the Notice to Proceed may be extended.
- 01.23 Owner St. Tammany Parish Government, acting herein through its duly constituted and authorized representative, including but not limited to the Office of the Parish President or its designee, its Chief Administrative Officer, and/or Legal Counsel. St. Tammany Parish Government (hereinafter, the "Parish") and Owner may be used interchangeably.
- 01.24 Project The entire construction to be performed as provided in the Contract Documents.
- 01.25 Project Representative The authorized representative of the Owner who is assigned to the Project or any parts thereof.
- 01.26 Proposal The Bid submitted by the Bidder to the Owner on the Proposal form setting forth the Work to be done and the price for which the Bidder agrees to perform the Work.
- 01.27 Shop Drawings All drawings, diagrams, illustrations, brochures, schedules and other data which are prepared by the Contractor, Subcontractor, Manufacturer, Supplier or Distributor and which illustrate the equipment, material or some portion of the Work.
- 01.28 Specifications The Instructions to Bidders, these General Conditions, the Special Conditions and the Technical Provisions. All of the documents listed in the "Table of Contents."
- 01.29 Subcontractor An individual, firm or corporation having a direct Contract with the Contractor or with any other Subcontractor for the performance of a part of the Project Work.
- 01.30 Substantial Completion The date as certified by the Owner or its agent when the construction of the Project or a specified part thereof is sufficiently complete in accordance with the Contract Documents so that the Project or specified part can be utilized for the

purposes for which it was intended; or if there is no such certification, the date when final payment is due in accordance with Section 28.

- 01.31 Superintendent Contractor's site representative. The person on the site who is in full and complete charge of the Work.
- 01.32 Time Unless specifically stated otherwise, all time delays shall be calculated in calendar days.
- 01.33 Work Any and all obligations, duties and responsibilities necessary to the successful completion of the Project assigned to or undertaken by the Contractor under the Contract Documents, usually including the furnishing of all labor, materials, equipment and other incidentals.
- 01.34 The terms "he/himself" may be used interchangeably with "it/itself."

02.00 PROPOSAL

- 02.01 All papers bound with or attached to the Proposal Form are a necessary part thereof and must not be detached.
- 02.02 For submitting Bids, the only forms allowed shall be the "Louisiana Uniform Public Work Bid Form", "Louisiana Uniform Public Works Bid Form Unit Price Form" (if necessary), the Bid Bond, and written evidence of authority of person signing the bid. Necessary copies of the Louisiana Uniform Public Work Forms will be furnished for Bidding. Bound sets of the Contract Documents are for Bidder's information and should not be used in submitting Bids.
- 02.03 Proposal forms must be printed in ink or typed, unless submitted electronically. Illegibility or ambiguity therein may constitute justification for rejection of the Bid.
- 02.04 Each Bid must be submitted in a sealed envelope, unless submitted electronically. The outside of the envelope shall show the name and address of the Bidder, the State Contractor's License Number of the Bidder (if work requires contractor's license), and the Project name and number for which the Bid is submitted, along with the Bid number.
- 02.05 The price quoted for the Work shall be stated in words and figures on the Bid Form, and in numbers only on the Unit Price Form. The price in the Proposal shall include all costs necessary for the complete performance of the Work in full conformity with the conditions of the Contract Documents, and shall include all applicable Federal, State, Parish, Municipal or other taxes. The price bid for the items listed on the Unit Price Form will include the cost of all related items not listed, but which are normally required to do the type of Work bid.
- 02.06 The Bid shall be signed by the Bidder. The information required on the Louisiana Uniform Public Work Bid Form must be provided. Evidence of agency, corporate, or partnership authority is required and shall be provided in conformance with LSA-R.S. 38:2212(B).
- 02.07 Only the Contractors licensed by the State to do the type of Work involved can submit a Proposal for the Work. The envelope containing the Proposal shall have the Contractor's license number on it. Failure to be properly licensed constitutes authority by the Owner for rejection of Bid.
- 02.08 Bidders shall not attach any conditions or provisions to the Proposal. Any conditions or provisions so attached may, at the sole option of the Owner, cause rejection of the Bid or Proposal.
- 02.09 A Bid Guarantee of five percent (5%) of the amount of the total Bid, including Alternates, must accompany the Proposal and, at the option of the Bidder, may be a cashier's check, certified check or a satisfactory Bid Bond. The Bid Guarantee must be attached to the Louisiana Uniform Public Work Bid Form. No Bid will be considered unless it is so guaranteed. Cashier's check or certified check must be made payable to the order of the Owner. Cash deposits will not be accepted. The Owner reserves the right to cash or deposit the cashier's check or certified check. Such guarantees shall be made payable to the Parish

of St. Tammany. In accordance with LSA-R.S. 38:2218(C), if a bid bond is used, it shall be written by a surety or insurance company currently on the U.S. Department of the Treasury Financial Management Service list of approved bonding companies which is published annually in the Federal Register, or by a Louisiana domiciled insurance company with at least an A- rating in the latest printing of the A.M. Best's Key Rating Guide to write individual bonds up to ten percent of policyholders' surplus as shown in the A.M. Best's Key Rating Guide, or by an insurance company in good standing licensed to write bid bonds which is either domiciled in Louisiana or owned by Louisiana residents. It is **not** required to be on any AIA form.

- 02.10 Bid securities of the three (3) lowest Bidders will be retained by the Owner until the Contract is executed or until final disposition is made of the Bids submitted. Bid securities of all other Bidders will be returned promptly after the canvas of Bids. Bids shall remain binding for forty-five (45) days after the date set for Bid Opening. The Parish shall act within the forty-five (45) days to award the contract to the lowest responsible bidder or reject all bids as permitted by Public Bid Law. However, the Parish and the lowest responsible bidder, by mutual written consent, may agree to extend the deadline for award by one or more extensions of thirty (30) calendar days. In the event the Owner issued the Letter of Award during this period, or any extension thereof, the Bid accepted shall continue to remain binding until the Execution of the Contract.
- 02.11 A Proposal may be withdrawn at any time prior to the scheduled closing time for receipt of Bids, provided the request is in writing, executed by the Bidder or its duly authorized representative and is filed with the Owner prior to that time. When such a request is received, the Proposal will be returned to the Bidder unopened.
- 02.12 Written communications, over the signature of the Bidder, to modify Proposals will be accepted and the Proposal corrected in accordance therewith if received by the Owner prior to the scheduled closing time for receipt of Bids. Oral, telephonic or telegraphic Modifications will not be considered.
- 02.13 No oral interpretation obligating the Owner will be made to any Bidder as to the meaning of the Drawings, Specifications and Contract Documents. Every request for such an interpretation shall be made in writing and addressed and forwarded to the Owner. No inquiry received within seven (7) days prior to the day fixed for opening of the Bids shall be given consideration. Every interpretation made to the Bidder shall be in the form of an addendum to the Specifications. All such Addenda shall become part of the Contract Documents. Failure of Bidder to receive any such interpretation shall not relieve any Bidder from any obligation under this Bid. All Addenda shall be issued in accordance with the Public Bid Law, LSA-R.S. 38:2212(O)(2)(a) and (b).
- 02.14 The Owner reserves the right to reject any or all Bids for just cause in accordance with the Public Bid Law, LSA-R.S. 38:2214(B). Incomplete, informal or unbalanced Bids may be rejected. Reasonable grounds for belief that any one Bidder is concerned directly or indirectly with more than one Bid will cause rejection of all Bids wherein such Bidder is concerned. If required, a Bidder shall furnish satisfactory evidence of its competence and ability to perform the Work stipulated in its Proposal. Incompetence will constitute cause for rejection. If the Parish determines that the bidder is not responsive or responsible for any reason whatsoever, the bid may be rejected in accordance with State law.
- 02.15 The Contractor shall indemnify and hold harmless the Owner from any and all suits, costs, penalties or claims for infringement by reason of use or installation of any patented design, device, material or process, or any trademark and copyright in connection with the Work agreed to be performed under this Contract, and shall indemnify and hold harmless the Owner for any costs, expenses and damages which it may be obliged to pay by reason of any such infringement at any time during the prosecution or after completion of the Work.
- 02.16 Bidders shall familiarize themselves with and shall comply with all applicable Federal and State Laws, municipal ordinances and the rules and regulations of all authorities having jurisdiction over construction of the Project, which may directly or indirectly affect the Work or its prosecution. These laws and/or ordinances will be deemed to be included in the Contract, as though herein written in full.
- 02.17 Each Bidder shall visit the site of the proposed Work and fully acquaint itself with all surface and subsurface conditions as they may exist so that it may fully understand this

Contract. Bidder shall also thoroughly examine and be familiar with drawings, Specifications and Contract Documents. The failure or omission of any Bidder to receive or examine any form instrument, Drawing or document or to visit the site and acquaint itself with existing conditions, shall in no way relieve any Bidder from any obligation with respect to its Bid and the responsibility in the premises.

- 02.18 The standard contract form enclosed with the Proposal documents is a prototype. It is enclosed with the Contract Documents for the guidance of the Owner and the Contractor. It has important legal consequences in all respects and consultation with an attorney is encouraged. Contractor shall be presumed to have consulted with its own independent legal counsel.
- 02.19 When one set of Contract plans show the Work to be performed by two or more prime Contractors, it is the responsibility of each Bidder to become knowledgeable of the Work to be performed by the other where the Work upon which this bid is submitted is shown to come into close proximity or into conflict with the Work of the other. In avoiding conflicts, pressure pipe lines must be installed to avoid conflict with gravity pipe lines and the Bidder of the smaller gravity pipe line in conflict with the larger gravity pipe line must include in his Bid the cost of a conflict box at these locations. The location of and a solution to the conflicts do not have to be specifically noted as such on the plans.
- 02.20 Bidder shall execute affidavit(s) attesting compliance with LSA-R.S. 38:2212.10, 38:2224, 38:2227, each as amended, and other affidavits as required by law, prior to execution of the contract.
- 02.21 Sealed Proposals (Bid) shall be received by St. Tammany Parish Government at the office of St. Tammany Parish Government, Department of Procurement, 21454 Koop Drive, Suite 2-F, Mandeville, LA 70471, until the time and date denoted in Notice to Bidders, at which time and place the Proposals (Bids), shall be publicly opened and read aloud to those present. In accordance with LSA-R.S. 38-2212(A)(3)(c)(i), the designer's final estimated cost of construction shall be read aloud upon opening bids. Sealed Proposals (Bids) may also be mailed by certified mail to St. Tammany Parish Government, Department of Procurement, 21454 Koop Drive, Suite 2-F, Mandeville, LA 70471, and must be received before the bid opening. Bids may also be submitted electronically. Information concerning links for electronic bidding is contained in the Notice to Bidders.
- 02.22 Proposals (Bids) shall be executed on Forms furnished and placed in a sealed envelope, marked plainly and prominently as indicated in the Notice to Bidders, and these General Conditions, and addressed:

St. Tammany Parish Government
Department of Procurement
21454 Koop Drive, Suite 2-F
Mandeville, LA 70471

- 02.23 Complete sets of Drawings, Specifications, and Contract Documents may be secured at the Office of the Owner. See Notice to Bidders for deposit schedule.
- 02.24 The successful bidder shall be required to post in each direction a public information sign, 4' x 8' in size, at the location of the project containing information required by the Owner. The Owner shall supply this information.

03.00 AWARD, EXECUTION OF DOCUMENTS, BONDS, ETC.

- 03.01 The award of the Contract, if it is awarded, will be to the lowest responsible Bidder, in accordance with State Law. No award will be made until the Owner has concluded such investigations as it deems necessary to establish the responsibility, qualifications and financial ability and stability of the Bidder to do the Work in accordance with the Contract Documents to the satisfaction of the Owner within the time prescribed as established by the Department based upon the amount of work to be performed and the conditions of same. The written contract and bond shall be issued in conformance with LSA-R.S. 38:2216. The Owner reserves the right to reject the Bid of any Bidder in accordance with the Public Bid Law, LSA-R.S. 38:2214. If the Contract is awarded, the Owner shall give the successful Bidder written notice of the award within forty-five (45) calendar days after

the opening of the Bids in conformance with LSA-R.S. 38:2215(A), or any extension as authorized thereunder.

- 03.02 At least three counterparts of the Agreement and of such other Contract Documents as practicable shall be signed by the Owner and the Contractor. The Owner shall identify those portions of the Contract Documents not so signed and such identification shall be binding on both parties. The Owner and the Contractor shall each receive an executed counterpart of the Contract Documents.
- 03.03 Prior to the execution of the Agreement, the Contractor shall deliver to the Owner the required Bonds.
- 03.04 Failure of the successful Bidder to execute the Agreement and deliver the required Bonds within twenty (20) days of the Notice of the Award shall be just cause for the Owner to annul the award and declare the Bid and any guarantee thereof forfeited.
- 03.05 In order to ensure the faithful performance of each and every condition, stipulation and requirement of the Contract and to indemnify and save harmless the Owner from any and all damages, either directly or indirectly arising out of any failure to perform same, the successful Bidder to whom the Contract is awarded shall furnish a surety Bond in an amount of at least equal to one hundred percent (100%) of the Contract Price. The Contract shall not be in force or binding upon the Owner until such satisfactory Bond has been provided to and approved by the Parish. The cost of the Bond shall be paid for by the Contractor unless otherwise stipulated in the Special Provisions.
- 03.06 No surety Company will be accepted as a bondsman who has no permanent agent or representative in the State upon whom notices referred to in the General Conditions of these Specifications may be served. Services of said notice on said agent or representative in the State shall be equal to service of notice on the President of the Surety Company, or such other officer as may be concerned.
- 03.07 In conformance with LSA-R.S. 38:2219(A)(1)(a), (b), and (c):

Any surety bond written for a public works project shall be written by a surety or insurance company currently on the U.S. Department of the Treasury Financial Management Service list of approved bonding companies which is published annually in the Federal Register, or by a Louisiana domiciled insurance company with at least an A- rating in the latest printing of the A.M. Best's Key Rating Guide, to write individual bonds up to ten percent of policyholders' surplus as shown in the A.M. Best's Key Rating Guide or by an insurance company that is either domiciled in Louisiana or owned by Louisiana residents and is licensed to write surety bonds.

For any public works project, no surety or insurance company shall write a bond which is in excess of the amount indicated as approved by the U.S. Department of the Treasury Financial Management Service list or by a Louisiana domiciled insurance company with an A- rating by A.M. Best up to a limit of ten percent of policyholders' surplus as shown by A.M. Best; companies authorized by this Paragraph who are not on the treasury list shall not write a bond when the penalty exceeds fifteen percent of its capital and surplus, such capital and surplus being the amount by which the company's assets exceed its liabilities as reflected by the most recent financial statements filed by the company with the Department of Insurance.

In addition, any surety bond written for a public works project shall be written by a surety or insurance company that is currently licensed to do business in the state of Louisiana. All contractors must comply with any other applicable provisions of LSA-R.S. 38:2219.

- 03.08 Should the Contractor's Surety, even though approved and accepted by the Owner, subsequently remove its agency or representative from the State or become insolvent, bankrupt, or otherwise fail, the Contractor shall immediately furnish a new Bond in another company approved by the Owner, at no cost to the Owner. The new Bond shall be executed under the same terms and conditions as the original Bond. The new bond shall be submitted within thirty (30) days of such time as the Owner notifies Contractor or from the time Contractor learns or has reason to know that the original surety is no longer financially viable or acceptable to the Parish, whichever occurs first. In the event that Contractor fails

or refuses to timely secure additional surety, then the Owner may secure such surety and thereafter deduct such cost or expense from any sum due or to become due Contractor.

- 03.09 The Contractor's bondsman shall obligate itself to all the terms and covenants of these Specifications and of contracts covering the Work executed hereunder. The Owner reserves the right to do Extra Work or make changes by altering, adding to deducting from the Work under the conditions and in the manner herein before described without notice to the Contractor's surety and without in any manner affecting the liability of bondsman or releasing it from any of its obligations hereunder.
- 03.10 The Bond shall also secure for the Owner the faithful performance of the Contract in strict accordance with plans and Specifications. It shall protect the Owner against all lien laws of the State and shall provide for payment of reasonable attorney fees for enforcement of Contract and institution or concursus proceedings, if such proceedings become necessary. Likewise, it shall provide for all additional expenses of the Owner occurring through failure of the Contractor to perform.
- 03.11 The surety of the Contractor shall be and does hereby declare and acknowledge itself by acceptance to be bound to the Owner as a guarantor, jointly and in solido, with the Contractor, for fulfillment of terms of Section 03.00.
- 03.12 The performance Bond and Labor and Material Bond forming part of this Contract shall be continued by Contractor and its Surety for a period of one (1) year from date of acceptance of this Contract by Owner to assure prompt removal and replacement of all defective material, equipment, components thereof, workmanship, etc., and to assure payment of any damage to property of Owner or others as a result of such defective materials, equipment, workmanship, etc.
- 03.13 Contractor shall pay for the cost of recording the Contract and Bond and the cost of canceling same. Contractor shall also secure and pay for all Clear Lien and Privilege Certificates (together with any updates) which will be required before any final payment is made, and that may be required before any payment, at the request of the Owner, its representative, agent, architect, engineer and the like. All recordation and Clear Lien and Privilege Certificate requirements shall be in accordance with those requirements noted herein before in contract Specifications.

04.00 SUBCONTRACTS

- 04.01 Contractor shall be fully responsible for all acts and omissions of its Subcontractors and of persons and organizations for whose acts any of them may be liable to the same extent that it is responsible for the acts and omissions of persons directly employed by it. Nothing in the Contract Documents shall create any contractual relationship between Owner and any Subcontractor or other person or organization having a direct Contract with Contractor, nor shall it create any obligation on the part of the Owner to pay or to see to the payment of any monies due any Subcontractor.
- 04.02 Nothing in the Contract Documents shall be construed to control the Contractor in dividing the Work among approved Subcontractors or delineating the Work to be performed by any trade.
- 04.03 The Contractor agrees to specifically bind every Subcontractor to all of the applicable terms and conditions of the Contract Documents prior to commencing Work. Every Subcontractor, by undertaking to perform any of the Work, shall thereby automatically be deemed bound by such terms and conditions.
- 04.04 The Contractor shall indemnify and hold harmless the Owner and their agents and employees from and against all claims, damages, losses and expenses including Attorney's fees arising out of or resulting from the Contractor's failure to bind every Subcontractor and Contractor's surety to all of the applicable terms and conditions of the Contract Documents.

05.00 ASSIGNMENT

05.01 Neither party to this Contract shall assign or sublet its interest in this Contract without prior written consent of the other, nor shall the Contractor assign any monies due or to become due to it under this Contract without previous written consent of the Owner, nor without the consent of the surety unless the surety has waived its right to notice of assignment.

06.00 CORRELATION, INTERPRETATION AND INTENT OF CONTRACT DOCUMENTS.

06.01 It is the intent of the Specifications and Drawings to describe a complete Project to be constructed in accordance with the Contract Documents. The Contract Documents comprise the entire Agreement between Owner and Contractor. Alterations, modifications and amendments shall only be in writing between these parties.

06.02 The Contract Documents are intended to be complimentary and to be read *in pari materii*, and what is called for by one is as binding as if called for by all. If Contractor finds a conflict, error or discrepancy in the Contract Documents, it shall call it to the Owner's attention, in writing, at once and before proceeding with the Work affected thereby; however, it shall be liable to Owner for its failure to discover any conflict, error or discrepancy in the Specifications or Drawings. In resolving such conflicts, errors and discrepancies, the documents shall be given precedence in the following order: Agreement, Modifications, Addenda, Special Conditions, General Conditions, Construction Specifications and Drawings. The general notes on the plans shall be considered special provisions. Figure dimensions on Drawings shall govern over scale dimensions and detail Drawings shall govern over general Drawings. Where sewer connections are shown to fall on a lot line between two lots, the Contractor shall determine this location by measurement not by scale. Any Work that may reasonably be inferred from the Specifications or Drawings as being required to produce the intended result shall be supplied whether or not it is specifically called for. Work, materials or equipment described herein which so applied to this Project are covered by a well-known technical meaning or specification shall be deemed to be governed by such recognized standards unless specifically excluded.

06.03 Unless otherwise provided in the Contract Documents, the Owner will furnish to the Contractor (free of charge not to exceed ten (10) copies) Drawings and Specifications for the execution of Work. The Drawings and Specifications are the property of the Owner and are to be returned to it when the purpose for which they are intended have been served. The Contractor shall keep one copy of all Drawings and Specifications, including revisions, Addenda, details, Shop Drawings, etc. on the Work in good order and available to the Owner or the regulatory agency of the governmental body having jurisdiction in the area of the Work.

07.00 SHOP DRAWINGS, BROCHURES AND SAMPLES

07.01 After checking and verifying all field measurements, Contractor shall submit to Owner for approval, five copies (or at Owner's option, one reproducible copy) of all Shop Drawings, which shall have been checked by and stamped with the approval of Contractor and identified as Owner may require. The data shown on the Shop Drawings will be complete with respect to dimensions, design criteria, materials of construction and the like to enable Owner to review the information as required.

07.02 Contractor shall also submit to Owner, for review with such promptness as to cause no delay in Work, all samples as required by the Contract Documents. All samples will have been checked by and stamped with the approval of Contractor identified clearly as to material, manufacturer, any pertinent catalog numbers and the use for which intended. At the time of each submission, Contractor shall in writing call Owner's attention to any deviations that the Shop Drawings or samples may have from the requirements of the Contract Documents.

07.03 Owner will review with reasonable promptness Shop Drawings and samples, but its review shall be only for conformance with the design concept of the Project and for compliance with the information given in the Contract Documents. The review of a separate item as such will not indicate approval of the assembly in which the item functions. Contractor shall make any corrections required by Owner and shall return the required number of

corrected copies of Shop Drawings and resubmit new samples for review. Contractor shall direct specific attention in writing or on resubmitted Shop Drawings to revisions other than the corrections called for by Owner on previous submissions. Contractor's stamp of approval on any Shop Drawing or sample shall constitute a representation to Owner that Contractor has determined and verified all quantities, dimensions, field construction criteria, materials catalog numbers and similar data and thereafter assumes full responsibility for doing so, and that it has reviewed or coordinated each Shop Drawing or sample with the requirements of the Work and the Contract Documents.

07.04 Where a Shop Drawing or sample submission is required by the Specifications, no related Work shall be commenced until the submission has been reviewed by Owner. A copy of each reviewed shop Drawing and each inspected sample shall be kept in good order by Contractor at the site and shall be available to Owner.

07.05 Owner's review of Shop Drawings or samples shall not relieve Contractor from its responsibility for any deviations from the requirements of the Contract Documents unless Contractor has in writing called Owner's attention to such deviation at the time of submission and Owner has given written approval to the specific deviation, nor shall any review by Owner relieve Contractor from responsibility for errors or omissions in the Shop Drawings. The mere submittal of shop drawings which contain deviations from the requirements of plans, specifications and/or previous submittals in itself does not satisfy this requirement.

08.00 RECORD DRAWINGS

08.01 The Contractor shall keep an accurate record in a manner approved by the Owner of all changes in the Contract Documents during construction. In Work concerning underground utilities, the Contractor shall keep an accurate record in a manner approved by the Owner of all valves, fittings, etc. Before the Work is accepted by the Owner, and said acceptance is recorded, the Contractor shall furnish the Owner a copy of this record.

08.02 Contractor shall keep an accurate drawing measured in the field to the nearest 0.1' of the location of all sewer house connections. The location shown shall be the end of the connection at the property line measured along the main line of pipe from a manhole.

08.03 Contractor shall keep an accurate drawing of the storm water drainage collection system. Inverts to the nearest 0.01' and top of castings shall be shown as well as location of all structures to the nearest 0.1'. Upon completion of the Work, the plan will be given to the Owner.

09.00 PROGRESS OF WORK

09.01 Contractor shall conduct the Work in such a professional manner and with sufficient materials, equipment and labor as is considered necessary to ensure its completion within the time limit specified.

09.02 The Owner shall issue a Notice to Proceed to the Contractor within twenty (20) calendar days from the date of execution of the Contract. Upon mutual consent by both parties, the Notice to Proceed may be extended. The Contractor is to commence Work under the Contract within ten (10) calendar days from the date the Notice to Proceed is issued by the Owner.

09.03 The Contractor, immediately after being awarded the Contract, shall prepare and submit for the Owner's approval an estimated progress schedule for the work to be performed, as well as a construction signing layout for all roads within the project area. The Contractor shall not start work or request partial payment until the work schedule has been submitted to the Owner for approval.

09.04 Revisions to the original schedule will be made based on extension of days granted for inclement weather or change orders issued under the contract. No other revision shall be made which affects the original completion or updated completion date, whichever is applicable.

09.05 Failure of the Contractor to submit an estimated progress schedule or to complete timely and on schedule the Work shown on the progress schedule negates any and all causes or claims by the Contractor for accelerated completion damages. These accelerated damage claims shall be deemed forfeited.

09.06 Meetings will be held as often as necessary to expedite the progress of the job. Meetings will be held during normal working hours at the jobsite and shall be mandatory for the Contractor and all Sub-Contractors working on the project. Meetings may be requested by the Owner at any time and at the discretion of the Owner.

10.00 OWNER'S RIGHT TO PROCEED WITH PORTIONS OF THE WORK

10.01 Upon failure of the Contractor to comply with any notice given in accordance with the provisions hereof, the Owner shall have the alternative right, instead of assuming charge of the entire Work, to place additional forces, tools, equipment and materials on parts of the Work. The cost incurred by the Owner in carrying on such parts of the Work shall be payable by the Contractor. Such Work shall be deemed to be carried on by the Owner on account of the Contractor. The Owner may retain all amounts of the cost of such Work from any sum due Contractor or those funds that may become due to Contractor under this Agreement.

10.02 Owner may perform additional Work related to the Project by itself or it may let any other direct contract which may contain similar General Conditions. Contractor shall afford the other contractors who are parties to such different contracts (or Owner, if it is performing the additional Work itself) reasonable opportunity for the introduction and storage of materials and equipment and the execution of Work, and shall properly connect and coordinate its Work with the subsequent work.

10.03 If any part of Contractor's Work depends upon proper execution or results upon the Work of any such other contractor (or Owner), Contractor shall inspect and promptly report to Owner in writing any defects or deficiencies in such Work that render it unsuitable for such proper execution and results. Failure to so report shall constitute an acceptance of the other Work as fit and proper for the relationship of its Work except as to defects and deficiencies which may appear in the other Work after the execution of its Work.

10.04 Whatever Work is being done by the Owner, other Contractors or by this Contractor, the parties shall respect the various interests of the other parties at all times. The Owner may, at its sole discretion, establish additional rules and regulations concerning such orderly respect of the rights of various interests.

10.05 Contractor shall do all cutting, fitting and patching of its Work that may be required to integrate its several parts properly and fit to receive or be received by such other Work. Contractor shall not endanger any Work of others by cutting, excavating or otherwise altering Work and will only alter Work with the written consent of Owner and of the other contractors whose Work will be affected.

10.06 If the performance of additional Work by other contractors or Owner is not noted in the Contract Documents, written notice thereof shall be given to Contractor prior to starting any such additional Work. If Contractor believes that the performance of such additional Work by Owner or others may cause additional expense or entitles an extension of the Contract Time, the Contractor may make a claim therefor. The claim must be in writing to the Owner within thirty (30) calendar days of receipt of notice from the Owner of the planned additional Work by others.

11.00 TIME OF COMPLETION

11.01 The Notice to Proceed will stipulate the date on which the Contractor shall begin work. That date shall be the beginning of the Contract Time charges.

11.02 Contractor shall notify the Owner through its duly authorized representative, in advance, of where Contractor's work shall commence each day. A daily log shall be maintained by Contractor to establish dates, times, persons contacted, and location of work. Specific notice shall be made to the Owner if the Contractor plans to work on Saturday, Sunday, or

a Parish approved holiday. If notice is not received, no consideration will be given for inclement weather and same shall be considered a valid work day.

- 11.03 The Work covered by the Plans, Specifications and Contract Documents must be completed sufficiently for acceptance within the number of calendar days specified in the Proposal and/or the Contract, commencing from the date specified in the Notice to Proceed. It is hereby understood and mutually agreed, by and between the Contractor and the Owner, that the time of completion is an essential condition of this Contract, and it is further mutually understood and agreed that if the Contractor shall neglect, fail or refuse to complete the Work within the time specified, or any proper extension thereof granted by the Owner, then the Contractor does hereby agree, as partial consideration for the awarding of this Contract, to pay the Owner \$500.00 per day as specified in the Contract, not as a penalty, but as liquidated damages for such breach of contract for each and every calendar day that the Contractor shall be in default after the time stipulated in the Contract for completing the Work. It is specifically understood that the Owner shall also be entitled to receive a reasonable attorney fee and all costs in the event that Contractor fails to adhere to this agreement and this contract is referred to counsel for any reason whatsoever. Reasonable attorney fees shall be the prevailing hourly rate of the private sector, and in no event shall the hourly rate be less than \$175.00 per hour. All attorney fees shall be paid to the operating budget of the Office of the Parish President.
- 11.04 Prior to final payment, the Contractor may, in writing to the Owner, certify that the entire Project is substantially complete and request that the Owner or its agent issue a certificate of Substantial Completion. See Section 29.00.
- 11.05 The Owner may grant an extension(s) of time to the Contractor for unusual circumstances which are beyond the control of the Contractor and could not reasonably be foreseen by the Contractor prior to Bidding. Any such request must be made in writing to the Owner within seven (7) calendar days following the event occasioning the delay. The Owner shall have the exclusive and unilateral authority to determine, grant, and/or deny the validity of any such claim.
- 11.06 Extensions of time for inclement weather shall be processed as follows:

Commencing on the start date of each job, the Parish Inspector assigned to same shall keep a weekly log, indicating on each day whether inclement weather has prohibited the Contractor from working on any project within the specific job, based upon the following:

1. Should the Contractor prepare to begin work on any day in which inclement weather, or the conditions resulting from the weather, prevent work from beginning at the usual starting time, and the crew is dismissed as a result, the Contractor will not be charged for a working day whether or not conditions change during the day and the rest of the day becomes suitable for work.
2. If weather conditions on the previous day prevent Contractor from performing work scheduled, provided that no other work can be performed on any project within the package. The Parish Inspector shall determine if it is financially reasonable to require the Contractor to deviate from the schedule and relocate to another location.
3. If the Contractor is unable to work at least 60% of the normal work day due to inclement weather, provided that a normal working force is engaged on the job.

Any dispute of weather conditions as related to a specific job shall be settled by records of the National Weather Service.

- 11.07 Extensions of time for change orders

When a change order is issued, the Owner and Contractor will agree on a reasonable time extension, if any, to implement such change. Consideration shall be given for, but not limited to, the following:

1. If material has to be ordered;
2. Remobilization and or relocation of equipment to perform task; and
3. Reasonable time frame to complete additional work.

Time extensions for change orders shall be reflected on the official document signed by the Owner and Contractor.

- 11.08 At the end of each month, the Owner or its agent will furnish to the Contractor a monthly statement which reflects the number of approved days added to the contract. The Contractor will be allowed fourteen (14) calendar days in which to file a written protest setting forth in what respect the monthly statement is incorrect; otherwise, the statement shall be considered accepted by the Contractor as correct.
- 11.09 Apart from extension of time for unavoidable delays, no payment or allowance of any kind shall be made to the Contractor as compensation for damages because of hindrance or delay for any cause in the progress of the Work, whether such delay be avoidable or unavoidable.

12.00 LIQUIDATED DAMAGES

- 12.01 In case the Work is not completed in every respect within the time that may be extended, it is understood and agreed that per diem deductions of the sum of \$500.00 for liquidated damages, as stipulated in the Proposal and/or Contract, shall be made from the total Contract Price for each and every calendar day after and exclusive of the day on which completion was required, and up to the completion of the Work and acceptance thereof by the Owner. It is understood and agreed that time is of the essence to this Contract, and the above sum being specifically herein agreed upon in advance as the measure of damages to the Owner on account of such delay in the completion of the Work. It is further agreed that the expiration of the term herein assigned or as may be extended for performing the Work shall, *ipso facto*, constitute a putting in default, the Contractor hereby waiving any and all notice of default. The Contractor agrees and consents that the Contract Price, reduced by the aggregate of the entire damages so deducted, shall be accepted in full satisfaction of all Work executed under this Contract. It is further understood and agreed that Contractor shall be liable for a reasonable attorney fee and all costs associated with any breach of this agreement, including but not limited to this subsection. In the event that any dispute or breach herein causes referrals to counsel, then Contractor agrees to pay a reasonable attorney fee at the prevailing hourly rate of the private sector. In no event shall the hourly rate be less than \$175.00 per hour.

13.00 LABOR, MATERIALS, EQUIPMENT, SUPERVISION, PERMITS AND TAXES

- 13.01 The Contractor shall provide and pay for all labor, materials, equipment, supervision, subcontracting, transportation, tools, fuel, power, water, sanitary facilities and all incidentals necessary for the completion of the Work in substantial conformance with the Contract Documents.
- 13.02 The Contractor shall provide competent, suitably qualified personnel to survey and lay out the Work and perform construction as required by the Contract Documents. It shall at all times maintain good discipline and order at the site.
- 13.03 Unless otherwise specifically provided for in the Specifications, all workmanship, equipment, materials, and articles incorporated in the Work covered by this Contract are to be new and of the best grade of their respective kinds for the purpose intended. Samples of materials furnished under this Contract shall be submitted for approval to the Owner when and as directed.
- 13.04 Whenever a material or article required is specified or shown on the plans by using the name of a proprietary product or of a particular manufacturer or vendor, any material or article which shall perform adequately the duties imposed by the general design will be considered equal, and satisfactory, providing the material or article so proposed is of equal substance and function and that all technical data concerning the proposed substitution be approved by the Owner prior to the Bidding. The Owner shall have the exclusive and unilateral discretion to determine quality and suitability in accordance with LSA-R.S. 38:2212(T)(2).

- 13.05 Materials shall be properly and securely stored so as to ensure the preservation of quality and fitness for the Work, and in a manner that leaves the material accessible to inspection. Materials or equipment may not be stored on the site in a manner such that it will interfere with the continued operation of streets and driveways or other contractors working on the site.
- 13.06 The Contractor, by entering into the Contract for this Work, sets itself forth as an expert in the field of construction and it shall supervise and direct the Work efficiently and with its best skill and attention. It shall be solely responsible for the means, methods, techniques, sequences and procedures of construction.
- 13.07 Contractor shall keep on the Work, at all times during its progress, a competent resident Superintendent, who shall not be replaced without written Notice to Owner except under extraordinary circumstances. The Superintendent will be Contractor's representative at the site and shall have authority to act on behalf of Contractor. All communications given to the Superintendent shall be as binding as if given to the Contractor. Owner specifically reserves the right to approve and/or disapprove the retention of a new superintendent, all to not be unreasonably withheld.
- 13.08 Any foreman or workman employed on this Project who disregards orders or instructions, does not perform his Work in a proper and skillful manner, or is otherwise objectionable, shall, at the written request of the Owner, be removed from the Work and shall be replaced by a suitable foreman or workman.
- 13.09 The Contractor and/or its assigned representative shall personally ensure that all subcontracts and divisions of the Work are executed in a proper and workmanlike manner, on scheduled time, and with due and proper cooperation.
- 13.10 Failure of the Contractor to keep the necessary qualified personnel on the Work shall be considered cause for termination of the Contract by the Owner.
- 13.11 Only equipment in good working order and suitable for the type of Work involved shall be brought onto the job and used by the Contractor. The Contractor is solely responsible for the proper maintenance and use of its equipment and shall hold the Owner harmless from any damages or suits for damages arising out of the improper selection or use of equipment. No piece of equipment necessary for the completion of the Work shall be removed from the job site without approval of the Owner.
- 13.12 All Federal, State and local taxes due or payable during the time of Contract on materials, equipment, labor or transportation, in connection with this Work, must be included in the amount bid by the Contractor and shall be paid to proper authorities before acceptance. The Contractor shall furnish all necessary permits and certificates and comply with all laws and ordinances applicable to the locality of the Work. The cost of all inspection fees levied by any governmental entity whatsoever shall be paid for by the Contractor.
- 13.13 In accordance with St. Tammany Police Jury Resolution 86-2672, as amended, the Contractor must provide in a form suitable to the Owner an affidavit stating that all applicable sales taxes for materials used on this project have been paid.
- 13.14 During the period that this Contract is in force, neither party to the Contract shall solicit for employment or employ an employee of the other.
- 13.15 All materials or equipment shown on the Drawings or included in these specifications shall be furnished unless written approval of a substitute is obtained from the Designer, or Owner if no separate designer.
- 13.16 If a potential supplier wishes to submit for prior approval a particular product other than a product specified in the contract documents, he shall do so no later than seven working days prior to the opening of bids. Within three days, exclusive of holidays and weekends, after such submission, the prime design professional shall furnish to both the public entity and the potential supplier written approval or denial of the product submitted. The burden of proof of the equality of the proposed substitute is upon the proposer and only that information formally submitted shall be used by the Designer in making its decision.

13.17 The decision of the Designer/Owner shall be given in good faith and shall be final.

14.00 QUANTITIES OF ESTIMATE, CHANGES IN QUANTITIES, EXTRA WORK

14.01 Whenever the estimated quantities of Work to be done and materials to be furnished under this Contract are shown in any of the documents, including the Proposal, such are given for use in comparing Bids and the right is especially reserved, except as herein otherwise specifically limited, to increase or diminish same not to exceed twenty-five percent (25%) by the Owner to complete the Work contemplated by this Contract. Such increase or diminution shall in no way vitiate this Contract, nor shall such increase or diminution give cause for claims or liability for damages.

14.02 The Owner shall have the right to make alterations in the line, grade, plans, form or dimensions of the Work herein contemplated, provided such alterations do not change the total cost of the Project, based on the originally estimated quantities, and the unit prices bid by more than twenty-five percent (25%) and provided further that such alterations do not change the total cost of any major item, based on the originally estimated quantities and the unit price bid by more than twenty-five (25%). (A major item shall be construed to be any item, the total cost of which is equal to or greater than ten percent (10%) of the total Contract Price, computed on the basis of the Proposal quantity and the Contract unity price). Should it become necessary, for the best interest of the Owner, to make changes in excess of that herein specified, the same shall be covered by supplemental agreement either before or after the commencement of the Work and without notice to the sureties. If such alterations diminish the quantity of Work to be done, such shall not constitute a claim for damages for anticipated profits for the Work dispensed with, but when the reduction in amount is a material part of the Work contemplated, the Contractor shall be entitled to only reasonable compensation as determined by the Owner for overhead and equipment charges which it may have incurred in expectation of the quantity of Work originally estimated, unless specifically otherwise provided herein; if the alterations increase the amount of Work, the increase shall be paid according to the quantity of Work actually done and at the price established for such Work under this Contract except where, in the opinion of the Owner, the Contractor is clearly entitled to extra compensation.

14.03 Without invalidating the Contract, the Owner may order Extra Work or make changes by altering, adding to, or deducting from the Work, the Contract sum being adjusted accordingly. The consent of the surety must first be obtained when necessary or desirable, all at the exclusive discretion of the Owner. All the Work of the kind bid upon shall be paid for at the price stipulated in the Proposal, and no claims for any Extra Work or material shall be allowed unless the Work is ordered in writing by the Owner.

14.04 Extra Work for which there is no price or quantity included in the Contract shall be paid for at a unit price or lump sum to be agreed upon in advance in writing by the Owner and Contractor. Where such price and sum cannot be agreed upon by both parties, or where this method of payment is impracticable, the Owner may, at its exclusive and unilateral discretion, order the Contractor to do such Work on a Force Account Basis.

14.05 In computing the price of Extra Work on a Force Account Basis, the Contractor shall be paid for all foremen and labor actually engaged on the specific Work at the current local rate of wage for each and every hour that said foremen and labor are engaged in such Work, plus ten percent (10%) of the total for superintendence, use of tools, overhead, direct & indirect costs/expenses, pro-rata applicable payroll taxes, pro-rata applicable workman compensation benefits, pro-rata insurance premiums and pro-rata reasonable profit. The Contractor shall furnish satisfactory evidence of the rate or rates of such insurance and tax. The Contractor will not be able to collect any contribution to any retirement plans or programs.

14.06 For all material used, the Contractor shall receive the actual cost of such material delivered at the site of the Work, as shown by original receipted bill, to which shall be added five percent (5%). There will be absolutely no additional surcharges or additional fees attached hereto with respect to this subsection.

14.07 For any equipment used that is owned by the Contractor, the Contractor shall be allowed a rental based upon the latest prevailing rental price, but not to exceed a rental price as determined by the Associated Equipment Distributors (A.E.D. Green Book).

- 14.08 The Contractor shall also be paid the actual costs of transportation for any equipment which it owns and which it has to transport to the Project for the Extra Work. There will be absolutely no additional surcharges or additional fees attached hereto with respect to this subsection.
- 14.09 If the Contractor is required to rent equipment for Extra Work, but not required for Contract items, it will be paid the actual cost of rental and transportation of such equipment to which no percent shall be added. The basis upon which rental cost are to be charged shall be agreed upon in writing before the Work is started. Actual rental and transportation costs shall be obtained from receipted invoices and freight bills.
- 14.10 No compensation for expenses, fees or costs incurred in executing Extra Work, other than herein specifically mentioned herein above, will be allowed.
- 14.11 A record of Extra Work on Force Account basis shall be submitted to the Owner on the day following the execution of the Work, and no less than three copies of such record shall be made on suitable forms and signed by both the Owner or his representative on the Project and the Contractor. All bids for materials used on extra Work shall be submitted to the Owner by the Contractor upon certified statements to which will be attached original bills covering the costs of such materials.
- 14.12 Payment for Extra Work of any kind will not be allowed unless the same has been ordered in writing by the Owner.
- 15.00 STATUS OF THE ENGINEER (NOT APPLICABLE)
- 16.00 INJURIES TO PERSONS AND PROPERTY
- 16.01 The Contractor shall be held solely and exclusively responsible for all injuries to persons and for all damages to the property of the Owner or others caused by or resulting from the negligence of itself, its employees or its agents, during the progress of or in connection with the Work, whether within the limits of the Work or elsewhere under the Contract proper or as Extra Work. This requirement will apply continuously and not be limited to normal working hours or days. The Owner's construction review is for the purpose of checking the Work product produced and does not include review of the methods employed by the Contractor or to the Contractor's compliance with safety measures of any nature whatsoever. The Contractor agrees to pay a reasonable attorney fee and other reasonable attendant costs of the Owner in the event it becomes necessary for the Owner to employ an attorney to enforce this section or to protect itself against suit over the Contractor's responsibilities. Attorney fees shall be at the prevailing hourly rate of the private sector. The attorney fee hourly rate shall not be less than \$175.00 per hour. All attorney fees collected shall be paid to the operating budget of the Office of the Parish President.
- 16.02 The Contractor must protect and support all utility infrastructures or other properties which are liable to be damaged during the execution of its Work. It shall take all reasonable and proper precautions to protect persons, animals and vehicles or the public from the injury, and wherever necessary, shall erect and maintain a fence or railing around any excavation, and place a sufficient number of lights about the Work and keep same burning from twilight until sunrise, and shall employ one or more watchmen as an additional security whenever needed. The Contractor understands and agrees that the Owner may request that security be placed on the premises to ensure and secure same. The Owner shall have exclusive authority to request placement of such security. Contractor agrees to retain and place security as requested, all at the sole expense of Contractor. Additional security shall not be considered a change order or reason for additional payment by the Owner. The Contractor must, as far as practicable and consistent with good construction, permit access to private and public property and leave fire hydrants, catch basins, streets, etc., free from encumbrances. The Contractor must restore at its own expense all injured or damaged property caused by any negligent act of omission or commission on its part or on the part of its employees or subcontractors, including, but not limited to, sidewalks, curbing, sodding, pipes conduits, sewers, buildings, fences, bridges, retaining walls, tanks, power lines, levees or any other building or property whatsoever to a like condition as existed prior to such damage or injury.

- 16.03 In case of failure on the part of the Contractor to restore such property or make good such damage, the Owner may upon forty-eight (48) hours' notice proceed to repair or otherwise restore such property as may be deemed necessary, and the cost thereof will be deducted from any monies due or which may become due under its Contract.
- 16.04 Contractor agrees to protect, defend, indemnify, save, and hold harmless St. Tammany Parish Government, its elected and appointed officials, departments, agencies, boards and commissions, their officers, agents servants, employees, including volunteers, from and against any and all claims, demands, expense and liability arising out of injury or death to any person or the damage, loss or destruction of any property to the extent caused by any negligent act or omission or willful misconduct of Contractor, its agents, servants, employees, and subcontractors, or any and all costs, expense and/or attorney fees incurred by St. Tammany Parish Government as a result of any claim, demands, and/or causes of action that results from the negligent performance or non-performance by Contractor, its agents, servants, employees, and subcontractors of this contract. Contractor agrees to investigate, handle, respond to, provide defense for and defend any such claims, demand, or suit at its sole expense and agrees to bear all other costs and expenses related thereto caused by any negligent act or omission or willful misconduct of Contractor, its agents, servants, employees, and subcontractors.
- 16.05 As to any and all claims against Owner, its agents, assigns, representatives or employees by any employee of Contractor, any Subcontractor, anyone directly or indirectly employed by any of them or anyone for whose acts as may be liable, the indemnification obligation under Paragraph 16.04 shall not be limited in any way or by any limitation on the amount or type of damages, compensation or benefits payable by or for Contractor or any Subcontractor under workmen's compensation acts, disability benefit acts or other employee benefit acts.
- 16.06 No road shall be closed by the Contractor to the public except by written permission of the Owner. If so closed, the Contractor shall maintain traffic over, through and around the Work included in his Contract, with the maximum practical convenience, for the full twenty-four hours of each day of the Contract, whether or not Work has ceased temporarily. The Contractor shall notify the Owner at the earliest possible date after the Contract has been executed and, in any case, before commencement of any construction that might in any way inconvenience or endanger traffic, in order that necessary and suitable arrangements may be determined. Any and all security, maintenance, labor or costs associated with traffic control herein shall be at the sole expense of Contractor. This expense shall be paid directly by the Contractor. This expense shall not be considered as a change order nor shall it allow the Contractor any additional cost reimbursement whatsoever. All traffic deviations herein shall be coordinated with the appropriate law enforcement officials of this Parish.
- 16.07 The convenience of the general public and residents along the Works shall be provided for in a reasonable, adequate and satisfactory manner. Where existing roads are not available as detours, and unless otherwise provided, all traffic shall be permitted to pass through the Work. In all such cases, the public shall have precedence over Contractor's vehicles insofar as the traveling public's vehicles shall not be unduly delayed for the convenience of the Contractor. In order that all unnecessary delay to the traveling public may be avoided, the Contractor shall provide and station competent flagmen whose sole duties shall consist of directing and controlling the movement of public traffic either through or around the Work. Any and all security, maintenance, labor or costs associated with traffic control herein shall be at the sole expense of Contractor. This expense shall be paid directly by the Contractor. This expense shall not be considered as a change order nor shall it allow the Contractor any additional cost reimbursement whatsoever. All traffic deviations herein shall be coordinated with the appropriate law enforcement officials of this Parish.
- 16.08 The Contractor shall arrange its Work so that no undue or prolonged blocking of business establishments will occur.
- 16.09 Material and equipment stored on the right of way or work site shall be so placed and the Work at times shall be so conducted as to ensure minimum danger and obstruction to the traveling public.
- 16.10 During grading operations when traffic is being permitted to pass through construction, the Contractor shall provide a smooth, even surface that will provide a satisfactory passageway

for use of traffic. The road bed shall be sprinkled with water if necessary to prevent a dust nuisance, provided the dust nuisance is a result of the Work.

- 16.11 Fire hydrants shall be accessible at all times to the Fire Department. No material or other obstructions shall be placed closer to a fire hydrant than permitted by ordinances, rules or regulations or within fifteen (15) feet of a fire hydrant, in the absence of such ordinance, rules or regulations.
- 16.12 The Contractor shall not, without the written permission of the Owner, do Work for a resident or property owner abutting the Work at the time that this Work is in progress.
- 16.13 No Work of any character shall be commenced on railroad right-of-way until the Railroad Company has issued a permit to the Owner and has been duly notified by the Contractor in writing (with a copy forwarded to the Owner) of the date it proposes to begin Work, and until an authorized representative of the Railroad Company is present, unless the Railroad Company waives such requirements. All Work performed by the Contractor within the right-of-way limits of the railroad shall be subject to the inspection and approval of the chief engineer of the Railroad Company or its authorized representative. Any precautions considered necessary by said chief engineer to safeguard the property, equipment, employees and passengers of the Railroad Company shall be taken by the Contractor without extra compensation. The Contractor shall, without extra compensation, take such precautions and erect and maintain such tell-tale or warning devices as the Railroad Company considers necessary to safeguard the operation of its trains. The temporary vertical and horizontal clearance specified by the chief engineer of the Railroad Company in approving these shall be maintained at all times. No steel, brick, pipe or any loose material shall be left on the ground in the immediate vicinity of the railway track. Before any Work is done within Railroad right of way, the Contractor shall provide and pay all costs of any special insurance requirements of the Railroad.
- 16.14 The Contractor, shall, without extra compensation, provide, erect, paint and maintain all necessary barricades. Also, without extra compensation, the Contractor shall provide suitable and sufficient lights, torches, reflectors or other warning or danger signals and signs, provide a sufficient number of watchmen and flagmen and take all the necessary precautions for the protection of the Work and safety of the Public.
- 16.15 The Contractor shall erect warning signs beyond the limits of the Project, in advance of any place on the Project where operations interfere with the use of the road by traffic, including all intermediate points where the new Work crosses or coincides with the existing road. All barricades and obstructions shall be kept well painted and suitable warning signs shall be placed thereon. All barricades and obstructions shall be illuminated at night and all lights or devices for this purpose shall be kept burning from sunset to sunrise.
- 16.16 Whenever traffic is maintained through or over any part of the Project, the Contractor shall clearly mark all traffic hazards. No direct payment will be made for barricades, signs and illumination therefore or for watchmen or flagmen.
- 16.17 The Contractor will be solely and completely responsible for conditions on the job site, including safety of all persons and property during performance of the Work. This requirement will apply continuously and not be limited to normal working hours. The duty of the Owner to conduct construction review of the Contractor's performance is not intended to include review of the adequacy of the Contractor's safety measures, in, or near the construction site.

17.00 SANITARY PROVISIONS

- 17.01 The Contractor shall provide and maintain in a neat, sanitary condition such accommodations for the use of its employees as may be necessary to comply with the rules and regulations of the State Health Agency or of the other authorities having jurisdiction and shall permit no public nuisance.

18.00 RIGHTS OF WAY

18.01 The Owner will furnish the Contractor with all necessary rights-of-way for the prosecution of the Work. The rights of way herein referred to shall be taken to mean only permission to use or pass through the locations or space in any street, highway, public or private property in which the Contractor is to prosecute the Work.

18.02 It is possible that all lands and rights of way may not be obtained as herein contemplated before construction begins, in which event the Contractor shall begin its Work upon such land and rights of way as the Owner may have previously acquired. Any delay in furnishing these lands by the Owner can be deemed proper cause for adjustment in the Contract amount and/or in the time of completion.

19.00 PROTECTION AND RESTORATION OF PROPERTY AND LANDSCAPE

19.01 The Contractor shall not enter upon private property for any purpose without first obtaining permission from the Owner, as well as the private property owner and/or and private property Lessees. The Contractor shall use every precaution necessary for the preservation of all public and private property, monuments, highway signs, telephone lines, other utilities, etc., along and adjacent to the Work; the Contractor shall use every precaution necessary to prevent damage to pipes, conduits, and other underground structures; and shall protect carefully from disturbance or damage all land monuments and property marks until an authorized agent has witnessed or otherwise referenced their location and shall not remove them until directed. The street and highway signs and markers that are to be affected by the Work shall be carefully removed when the Work begins and stored in a manner to keep them clean and dry. The Contractor must obtain all necessary information in regard to existing utilities and shall give notice in writing to the owners or the proper authorities in charge of streets, gas, water, pipes, electric, sewers and other underground structures, including conduits, railways, poles and pole lines, manholes, catch basins, fixtures, appurtenances, and all other property that may be affected by the Contractor's operations, at least forty-eight (48) hours before its operations will affect such property. The Contractor shall not hinder or interfere with any person in the protection of such Work or with the operation of utilities at any time. When property, the operation of railways, or other public utilities are endangered, the Contractor shall at its own expense, maintain flagmen or watchmen and any other necessary precautions to avoid interruption of service or damage to life or property, and it shall promptly repair, restore, or make good any injury or damage caused by its negligent operations in an acceptable manner. The Contractor must also obtain all necessary information in regard to the installation of new cables, conduits, and transformers, and make proper provisions and give proper notifications, in order that same can be installed at the proper time without delay to the Contractor or unnecessary inconvenience to the Owner.

19.02 The Contractor shall not remove, cut or destroy trees, shrubs, plants, or grass that are to remain in the streets or those which are privately owned, without the proper authority. Unless otherwise provided in the Special Provisions or the Proposal, the Contractor shall replace and replant all plants, shrubs, grass and restore the grounds back to its original good condition to the satisfaction of the Owner and/or the property owner. The Contractor shall assume the responsibility of replanting and guarantees that plants, shrubs, grass will be watered, fertilized and cultivated until they are in a growing condition. No direct payment will be made for removing and replanting of trees, shrubs, plants or grass unless such items are set forth in the Proposal.

19.03 When or where direct damage or injury is done to public or private property by or on account of any negligent act, omission, neglect or otherwise of the Contractor, it shall make good such damage or injury in an acceptable manner.

20.00 CONTRACTORS RESPONSIBILITY FOR WORK

20.01 Until final acceptance of the Work by the Owner as evidence by approval of the final estimate, the Work shall be in the custody and under the charge and care of the Contractor and it shall take every necessary precaution against injury or damage to any part thereof by the action of the elements or from the non-execution of the Work; unless otherwise provided for elsewhere in the Specifications or Contract. The Contractor shall rebuild, repair, restore and make good, without extra compensation, all injuries or damages to any portion of the Work occasioned by any of the above causes before its completion and

acceptance, and shall bear the expenses thereof. In case of suspension of the Work from any cause whatever, the Contractor shall be responsible for all materials and shall properly and securely store same, and if necessary, shall provide suitable shelter from damage and shall erect temporary structures where necessary. If in the exclusive discretion of the Owner, any Work or materials shall have been damaged or injured by reason of failure on the part of the Contractor or any of its Subcontractors to so protect the Work, such materials shall be removed and replaced at the sole expense of the Contractor. Such amount shall be deducted from any sum due or to be due Contractor.

20.02 The Contractor shall give all notice and comply with all Federal, State, and local laws, ordinances, and regulations in any manner affecting the conduct of the Work, and all such orders and decrees as exist, or may be enacted by bodies or tribunals having any jurisdiction or authority over the Work, and shall indemnify and hold harmless the Owner against any claim or liability arising from, or based on, the violation of any such law, ordinance, regulation, order or decree, whether by itself, its employees or Subcontractors.

21.00 TESTS AND INSPECTIONS CORRECTION & REMOVAL OF DEFECTIVE WORK

21.01 Contractor warrants and guarantees to Owner that all materials and equipment will be new unless otherwise specified and that all Work will be of good quality and free from faults or defects and in accordance with the requirements of the Contract Documents. All unsatisfactory Work, all faulty or Defective Work and all Work not conforming to the requirements of the Contract Documents at the time of acceptance shall be considered Defective. Prompt and reasonable notice of all defects shall be given to the Contractor.

21.02 If the Contract Documents, laws, ordinances, rules, regulations or orders of any public authority having jurisdiction require any Work to specifically be inspected, tested or approved by some public body, Contractor shall assume full responsibility therefor, pay all costs in connection therewith and furnish Owner the required certificates of inspection, testing or approval. All other inspections, tests and approval required by the Contract Documents shall be performed by organizations acceptable to Owner and Contractor and the costs thereof shall be borne by the Contractor unless otherwise specified.

21.03 Contractor shall give Owner timely notice of readiness of the Work for all inspections, tests or approvals. If any such Work required to be inspected, tested or approved is covered without written approval of Owner, it must, if requested by Owner, be uncovered for observation, and such uncovering shall be at Contractor's expense unless Contractor has given Owner timely notice of its intention to cover such Work and Owner has not acted with reasonable promptness in response to such notice.

21.04 Neither observations by Owner nor inspections, tests or approvals shall relieve Contractor from its obligations to perform the Work in accordance with the requirements of the Contract Document.

21.05 Owner and its representatives will at reasonable times have access to the Work. Contractor shall provide proper and safe facilities for such access and observation of the Work and also for any inspection or testing thereof by others.

21.06 If any Work is covered contrary to the written request of Owner, it must, be uncovered for Owner's observation and replaced at Contractor's expense. If any Work has been covered which Owner has not specifically requested to observe prior to its being covered, or if Owner considers it necessary or advisable that covered Work be inspected or tested by others, the Contractor, at Owner's request, shall uncover, expose or otherwise make available for observations, inspections or testing as Owner may require, that portion of the Work in question, furnishing all necessary labor, material and equipment. If it is found that such Work is Defective, Contractor shall bear all the expenses of such uncovering, exposure, observation, inspection and testing and of satisfactory reconstruction, including compensation for additional professional services, and an appropriate deductive Change Order shall be issued. If, however, such Work is not found to be Defective, Contractor shall be allowed an increase in the Contract Price or an extension of the Contract Time, or both, directly attributable to such uncovering, exposure, observation, inspection, testing and reconstruction.

- 21.07 If the Work is Defective, or Contractor fails to supply sufficient skilled workmen or suitable materials or equipment, or if the Contractor fails to make prompt payments to Subcontractors or for labor, materials or equipment, Owner may order Contractor to stop the Work, or any portion thereof, until the cause of such order has been eliminated; however, this right of Owner to stop the Work shall not give rise to any duty on the part of Owner to exercise this right for the benefit of Contractor or any other party.
- 21.08 Prior to approval of final payment, Contractor shall promptly, without cost to Owner and as specified by Owner, either correct any Defective Work, whether or not fabricated, installed or completed, or if the Work has been rejected by Owner, remove it from the site and replace it with non-defective Work. If Contractor does not correct such Defective Work or remove and replace such rejected Work within a reasonable time, all as specified in a written notice from Owner, Owner may have the deficiency corrected or the rejected Work removed and replaced. All direct or indirect costs of such correction or removal and replacement including compensation for additional professional services shall be paid by Contractor, and an appropriate deductive Change Order shall be issued. Contractor shall also bear the expense of making good all Work of others destroyed or damaged by its correction, removal or replacement of its Defective Work.
- 21.09 If, after the approval of final payment and prior to the expiration of one year after the date of Substantial Completion or such longer period of time as may be prescribed by law or by the terms of any applicable special guarantee required by the Contract Documents, any Work is found to be Defective, Contractor shall promptly, without cost to Owner and in accordance with Owner's written instructions, either correct such Defective Work or if it has been rejected by Owner, remove it from the site and replace it with non-defective Work. If Contractor does not promptly comply with the terms of such instructions, Owner may have the Defective Work corrected or the rejected Work removed and replaced, and all direct and indirect costs of such removal and replacement, including compensation for additional professional services, shall be paid by Contractor. The Contractor agrees to pay a reasonable attorney fee and other reasonable attendant costs of the Owner in the event it becomes necessary for the Owner to employ an attorney to enforce this section or to protect itself against suit over the Contractor's responsibilities. Attorney fees shall be at the prevailing hourly rate of the private sector. The attorney fee hourly rate shall not be less than \$175.00 per hour. All attorney fees collected shall be paid to the operating budget of the Office of the Parish President.
- 21.10 If, instead of requiring correction or removal and replacement of Defective Work, Owner (and prior to approval of final payment) prefers to accept it, the Owner may do so. In such case, if acceptance occurs prior to approval of final payment, a Change Order shall be issued incorporating the necessary revisions in the Contract Documents, including appropriate reduction in the Contract Price, or, if the acceptance occurs after approval of final payment, an appropriate amount shall be paid by Contractor to Owner.
- 21.11 If Contractor should fail to progress the Work in accordance with the Contract Documents, including any requirements of the Progress Schedule, Owner, after seven (7) days written Notice to Contractor, may, without prejudice to any other remedy Owner may have, make good such deficiencies and the cost thereof including compensation for additional professional services shall be charged against Contractor. In such cases, a Change Order shall be issued incorporating the necessary revisions in the Contract Documents including an appropriate reduction in the Contract Price. If the payments then or thereafter due Contractor are not sufficient to cover such amount, Contractor shall pay the difference to Owner.
- 21.12 The Owner may appoint representatives to make periodic visits to the site and observe the progress and quality of the executed Work. These representatives shall be governed by the same restrictions placed on the Owner by these Specifications. The governing body of the Federal, State or local government exercising authority in the area of the Work may appoint representatives to observe the progress and quality of the Work. Contractor shall cooperate with and assist these representatives in the performance of their duties.
- 21.13 The Contractor shall be responsible for the faithful execution of its Contract and the presence or absence of the Owner's or Government's Representative is in no way or manner to be presumed or assumed to relieve in any degree the responsibility or obligation of the Contractor.

- 21.14 The Contractor shall notify the Owner and the Governmental Agency having jurisdiction as to the exact time at which it is proposed to begin Work so the Owner may provide for inspection of all materials, foundations, excavations, equipment, etc., and all or any part of the Work and to the preparation or manufacture of materials to be used whether within the limits of the Work or at any other place.
- 21.15 The Owner or its representatives shall have free access to all parts of the Work and to all places where any part of the materials to be used are procured, manufactured or prepared. The Contractor shall furnish the Owner all information relating to the Work and the material therefor, which may be deemed necessary or pertinent, and with such samples of materials as may be required. The Contractor, at its own expense, shall supply such labor and assistance as may be necessary in the handling of materials for proper inspection or for inspection of any Work done by it.
- 21.16 No verbal instructions given to the Contractor by the Owner, Project Representative or any of their agents shall change or modify the written Contract. Contractors shall make no claims for additional payments or time based upon verbal instructions.

22.00 SUBSURFACE CONDITIONS

- 22.01 It is understood and agreed that the Contractor is familiar with the subsurface conditions that will be encountered and its price bid for the Work includes all of the costs involved for Work in these conditions and it is furthermore agreed that it has taken into consideration, prior to its Bid and acceptance by Owner, all of the subsurface conditions normal or unusual that might be encountered in the location of the Work.
- 22.02 Should the Contractor encounter during the progress of the Work subsurface conditions at the site materially differing from those shown on the Drawings or indicated in the Specifications, the attention of the Owner shall be directed to such conditions before the conditions are disturbed. If the Owner finds that the conditions materially differ from those shown on the Drawings or indicated in the Specifications, it shall at once make such changes in the Drawings or Specifications as it may find necessary, and any increase or decrease in cost or extension of time resulting from such changes shall be adjusted in the same manner as provided for changes for Extra Work. The Contractor shall submit breakdowns of all costs in a manner as instructed and approved by the Owner.

23.00 REMOVAL AND DISPOSAL OF STRUCTURES AND OBSTRUCTIONS

- 23.01 Bidder shall thoroughly examine the site of the Work and shall include in its Bid the cost of removing all structures and obstructions in the way of the Work.
- 23.02 The Contractor shall remove any existing structures or part of structures, fence, building or other encumbrances or obstructions that interfere in any way with the Work. Compensations for the removal of any structure shall be made only if the item(s) to be removed was/were listed as pay item(s) on the Proposal.
- 23.03 If called for in the Special Conditions, all privately and publicly owned materials and structures removed shall be salvaged without damage and shall be piled neatly and in an acceptable manner upon the premises if it belongs to an abutting property owner, otherwise at accessible points along the improvements. Materials in structures which is the property of the Owner or property of any public body, private body or individual which is fit for use elsewhere, shall remain property of the original Owner. It shall be carefully removed without damage, in sections which may be readily transported; same shall be stored on or beyond the right of way. The Contractor will be held responsible for the care and preservation for a period of ten (10) days following the day the last or final portion of the materials stored at a particular location are placed thereon. When privately owned materials are stored beyond the right of way, the Contractor will be held responsible for such care and preservation for a period of ten (10) days responsibility period for care and preservation of the materials begins. The Contractor must furnish the Owner with evidence satisfactory that the proper owner of the materials has been duly notified by the Contractor that the said owner must assume responsibility for its materials on the date following the Contractor's ten (10) day responsibility.

24.00 INSURANCE

- 24.01 Contractor shall secure and maintain at its expense such insurance that will protect it and the Parish from claims for injuries to persons or damages to property which may arise from or in connection with the performance of Services or Work hereunder by the Contractor, his agents, representatives, employees, and/or subcontractors. The cost of such insurance shall be included in Contractor's bid.
- 24.02 The Contractor shall not commence work until it has obtained all insurance as required for the Parish Project. If the Contractor fails to furnish the Parish with the insurance protection required and begins work without first furnishing Parish with a currently dated certificate of insurance, the Parish has the right to obtain the insurance protection required and deduct the cost of insurance from the first payment due the Contractor. Further deductions are permitted from future payments as are needed to protect the interests of the Parish including, but not limited to, renewals of all policies.
- 24.03 Payment of Premiums: The insurance companies issuing the policy or policies shall have no recourse against the Parish of St. Tammany for payment of any premiums or for assessments under any form of policy.
- 24.04 Deductibles: Any and all deductibles in the described insurance policies shall be assumed by and be at the sole risk of the Contractor.
- 24.05 Authorization of Insurance Company(ies) and Rating: All insurance companies must be authorized to do business in the State of Louisiana and shall have an A.M. Best rating of no less than A-, Category VII.
- 24.06 Policy coverages and limits must be evidenced by Certificates of Insurance issued by Contractor's carrier to the Parish and shall reflect:

Date of Issue: Certificate must have current date.

Named Insured: The legal name of Contractor under contract with the Parish and its principal place of business shall be shown as the named insured on all Certificates of Liability Insurance.

Name of Certificate Holder: St. Tammany Parish Government, Office of Risk Management, P. O. Box 628, Covington, LA 70434

Project Description: A brief project description, including Project Name, Project Number and/or Contract Number, and Location.

Endorsements and Certificate Reference: All policies must be endorsed to provide, and certificates of insurance must evidence the following:

Waiver of Subrogation: The Contractor's insurers will have no right of recovery or subrogation against the Parish of St. Tammany, it being the intention of the parties that all insurance policy(ies) so affected shall protect both parties and be the primary coverage for any and all losses covered by the below described insurance. *Policy endorsements required for all coverages.*

Additional Insured: The Parish of St. Tammany shall be named as additional named insured with respect to general liability, marine liability, pollution/environmental liability, automobile liability and excess liability coverages. *Policy endorsements required.*

Hold Harmless: Contractor's liability insurers shall evidence their cognizance of the Hold Harmless and Indemnification in favor of St. Tammany Parish Government by referencing same on the face of the Certificate(s) of Insurance.

Cancellation Notice: Producer shall provide thirty (30) days prior written notice to the Parish of policy cancellation or substantive policy change.

24.07 The types of insurance coverage the Contractor is required to obtain and maintain throughout the duration of the Contract, include, but is not limited to:

1. Commercial General Liability insurance with a Combined Single Limit for bodily injury and property damage of at least \$1,000,000 per Occurrence/\$3,000,000 General Aggregate/Products-Completed Operations Per Project. The insurance shall provide for and the certificate(s) of insurance shall indicate the following coverages:
 - a) Premises - operations;
 - b) Broad form contractual liability;
 - c) Products and completed operations;
 - d) Personal Injury;
 - e) Broad form property damage;
 - f) Explosion and collapse.
2. Marine Liability/Protection and Indemnity insurance is required for any and all vessel and/or marine operations in the minimum limits of \$1,000,000 per occurrence/\$2,000,000 per project general aggregate. The coverage shall include, but is not limited to, the basic coverages found in the Commercial General Liability insurance and coverage for third party liability.
3. Contractors' Pollution Liability and Environmental Liability insurance in the minimum amount of \$1,000,000 per occurrence, \$2,000,000 general aggregate and include coverage for full contractual liability and for all such environmental and/or hazardous waste exposures affected by this project.
4. Business Automobile Liability insurance with a Combined Single Limit of \$1,000,000 per Occurrence for bodily injury and property damage, and shall include coverage for the following:
 - a) Any automobiles;
 - b) Owned automobiles;
 - c) Hired automobiles;
 - d) Non-owned automobiles;
 - e) Uninsured motorist.
5. Workers' Compensation/Employers Liability insurance: worker's compensation insurance coverage and limits as statutorily required; Employers' Liability Coverage shall be not less than \$1,000,000 each accident, \$1,000,000 each disease, \$1,000,000 disease policy aggregate, except when projects include exposures covered under the United States Longshoremen and Harbor Workers Act, Maritime and/or Jones Act and/or Maritime Employers Liability (MEL) limits shall be not less than \$1,000,000/\$1,000,000/\$1,000,000. *Coverage for owners, officers and/or partners shall be included in the policy and a statement of such shall be made by the insuring producer on the face of the certificate.*
6. Owners Protective Liability (OPL) (formerly Owners and Contractors Protective Liability (OCP) Insurance) shall be furnished by the Contractor naming St. Tammany Parish Government as the Named Insured and shall provide coverage in the minimum amount of \$1,000,000 combined single limit (CSL) each occurrence, \$2,000,000 aggregate. Any project valued in excess of \$3,000,000 shall be set by the Office of Risk Management. The policy and all endorsements shall be addressed to St. Tammany Parish Government, Office of Risk Management, P. O. Box 628, Covington, LA 70434.
7. Builder's Risk Insurance shall be required on buildings, sewage treatment plants and drainage pumping stations, and shall be written on an "all-risk" or equivalent policy form in the amount of the full value of the initial Contract sum, plus value of subsequent Contract modifications and cost of materials supplied or installed by others, comprising 100% total value for the entire project including foundations. Deductibles should not exceed \$5,000 and Contractor shall be responsible for any and all policy deductibles. This insurance shall cover portions of the work stored off the site, and also portions of the work in transit. In addition, Installation Floater

Insurance, on an “all-risk” form, will be carried on all pumps, motors, machinery and equipment on the site or installed. Both the Builder’s Risk Insurance and the Installation Floater Insurance shall include the interests of the Owner, Contractor, Subcontractors, and Sub-subcontractors and shall terminate only when the Project has been accepted. St. Tammany Parish Government, P. O. Box 628, Covington, LA 70434 shall be the first named insured on the Builder’s Risk and Installation Floater Insurance.

8. Professional Liability (errors and omissions) insurance in the sum of at least One Million Dollars (\$1,000,000) per claim with Two Million Dollars (\$2,000,000) annual aggregate.
 9. An umbrella policy or excess policy may be required and/or allowed to meet minimum coverage limits, subject to the review and approval by St. Tammany Parish Government, Office of Risk Management.
- 24.08 All policies of insurance shall meet the requirements of the Parish of St. Tammany prior to the commencing of any work. The Parish of St. Tammany has the right, but not the duty, to approve all insurance policies prior to commencing of any work. If at any time, it becomes known that any of the said policies shall be or becomes unsatisfactory to the Parish of St. Tammany as to form or substance; or if a company issuing any such policy shall be or become unsatisfactory to the Parish of St. Tammany, the Contractor shall promptly obtain a new policy, timely submit same to the Parish of St. Tammany for approval and submit a certificate thereof as provided above. The Parish agrees to not unreasonably withhold approval of any insurance carrier selected by Contractor. In the event that Parish cannot agree or otherwise authorize said carrier, Contractor shall have the option of selecting and submitting new insurance carrier within 30 days of said notice by the Parish. In the event that the second submission is insufficient or is not approved, then the Parish shall have the unilateral opportunity to thereafter select a responsive and responsible insurance carrier all at the cost of Contractor and thereafter deduct from Contractor's fee the cost of such insurance.
- 24.09 Upon failure of Contractor to furnish, deliver and/or maintain such insurance as above provided, the contract, at the election of the Parish of St. Tammany, may be forthwith declared suspended, discontinued or terminated. Failure of the Contractor to maintain insurance shall not relieve the Contractor from any liability under the contract, nor shall the insurance requirements be construed to conflict with the obligation of the Contractor concerning indemnification.
- 24.10 Contractor shall maintain a current copy of all annual insurance policies and provide same to the Parish of St. Tammany as may be reasonably requested.
- 24.11 It shall be the responsibility of Contractor to require that these insurance requirements are met by all contractors and sub-contractors performing work for and on behalf of Contractor. Contractor shall further ensure the Parish is named as additional insured on all insurance policies provided by said contractor and/or sub-contractor throughout the duration of the project, and that renewal certificates for any policies expiring prior to the Parish’s final acceptance of the project shall be furnished to St. Tammany Parish Government, Department of Legal, Office of Risk Management, without prompting.

NOTICE:

These are only an indication of the coverages that are generally required. Additional coverages and/or limits may be required for projects identified as having additional risks or exposures. Please note that some requirements listed may not necessarily apply to your specific services. St. Tammany Parish Government reserves the right to remove, replace, make additions to and/or modify any and all of the insurance requirement language upon review of the final scope of services presented to Department of Legal, Office of Risk Management prior to execution of a contract for services.

For inquiries regarding insurance requirements, please contact:

St. Tammany Parish Government

Legal Department

Office of Risk Management

P. O. Box 628

Covington, LA 70434

Telephone: 985-898-2797

Fax: 985-898-3070

Email: riskman@stpgov.org

24.12 Nothing contained in these insurance requirements is to be construed as limiting the extent of the Contractor's Responsibility for payment of damages resulting from its operations under this Contract.

25.00 OWNER'S RIGHT TO OCCUPANCY

25.01 The Owner shall have the right to use, at any time, any and all portions of the Work that have reached such a stage of completion as to permit such occupancy, provided such occupancy does not hamper the Contractor or prevent its efficient completion of the Contract or be construed as constituting an acceptance of any part of the Work.

25.02 The Owner shall have the right to start the construction of houses, structures or any other building concurrent with the Contractor's Work.

26.00 SURVEY HORIZONTAL AND VERTICAL CONTROL

26.01 The Owner shall provide surveys for construction to establish reference points which in its judgment are necessary to enable Contractor to layout and proceed with its Work. Contractor shall be responsible for surveying and laying out the Work and shall protect and preserve the established reference points and shall make no changes or relocations without the prior written approval of the Owner. Contractor shall report to Owner whenever any reference point is lost or destroyed and the Owner shall decide if the reference point shall be replaced by its or the Contractor's forces.

26.02 The Contractor shall establish lines and grades with its own forces in sufficient number and location for the proper execution of the Work.

26.03 If the Contractor, during the construction, damages the established property corners and/or other markers and thereafter requests the Owner to re-stake same in order to complete the project, this expense will be borne solely by the Contractor.

27.00 TERMINATION OF THE CONTRACT, OWNER'S AND CONTRACTORS RIGHT TO STOP WORK.

27.01 If the Contractor should be adjudged bankrupt (voluntarily or involuntarily) or if it should make a general assignment for the benefit of its creditors, or if a receiver should be appointed on account of its insolvency, or if it should persistently or repeatedly refuse or should fail (except in cases for which extension of time is provided) to supply enough properly skilled workmen or proper materials, or if it should fail to make prompt payment to Subcontractors or for material or labor, or persistently disregard laws, ordinances or the

instructions of the Owner, or otherwise be guilty of a substantial violation of any provision of the Contract, then the Owner, upon the certificate of the Owner that, in its unilateral discretion and judgment, believes sufficient cause exists to justify such action, may, without prejudice to any other right or remedy and after giving the Contractor ten (10) calendar days written notice, terminate the employment of the Contractor and take possession of the premises and of all materials, tools and appliances thereon and finish the Work by whatever method the Owner may deem expedient.

- 27.02 Failure of the Contractor to start the Work within the time limit specified herein or substantial evidence that the progress being made by the Contractor is sufficient to complete the Work within the specified time shall be grounds for termination of the Contract by the Owner.
- 27.03 Before the Contract is terminated, the Contractor and its surety will first be notified in writing by the Owner of the conditions which make termination of the Contract imminent. When after ten (10) calendar days' notice is given and if satisfactory effort has not been made by the Contractor or its surety to correct the conditions, the Owner may declare, in its exclusive discretion, that the Contract is terminated and so notify the Contractor and its surety accordingly.
- 27.04 Upon receipt of notice from the Owner that the Contract has been terminated, the Contractor shall immediately discontinue all operations. The Owner may then proceed with the Work in any lawful manner that it may elect until Work is finally completed.
- 27.05 The exclusive right is reserved to the Owner to take possession of any machinery, implements, tools or materials of any description that shall be found upon the Work, to account for said equipment and materials, and to use same to complete the Project. When the Work is finally completed, the total cost of same will be computed. If the total cost is less than the Contract Price, the difference will not be paid to the Contractor or its surety.
- 27.06 In case of termination, all expenses incident to ascertaining and collecting losses under the Bond, including legal services, shall be assessed against the Bond.
- 27.07 If the Work should be stopped under any order of any court or public authority for period of sixty (60) calendar days, through no act or fault of the Contractor or anyone employed by it, or if the Owner shall fail to pay the Contractor within a reasonable time any sum certified by the Owner, then the Contractor may, upon ten (10) calendar days written notice to the Owner, stop Work or terminate this Contract and recover from the Owner payment for all Work properly and professionally executed in a workmanlike manner. This loss specifically includes actual cost of materials and equipment, together with all wages inclusive of all federal, state, and local tax obligations. This loss specifically includes reimbursement of all insurances on a pro-rata basis from the date of termination to date of policy period. This loss excludes and specifically does not include recovery by the Contractor for lost profit, indirect & direct expenses, overhead, and the like.

28.00 PAYMENTS TO THE CONTRACTOR

- 28.01 Monthly certificates for partial payment, in a form approved by the Owner, shall be transmitted to the Owner upon receipt from the Contractor and acceptance by the Owner. In accordance with LSA-R.S. 38:2248(A), when the Contract Price is less than five hundred thousand dollars, these certificates shall be equal to ninety percent (90%) of both the Work performed and materials stored at the site; and when the Contract Price is five hundred thousand dollars or more, these certificates shall be equal to ninety-five percent (95%) of both the Work performed and materials stored at the site. Partial payment certificates shall include only Work, materials and equipment that are included in official Work Order and which meet the requirements of plans, Specifications and Contract Documents. These monthly estimates shall show the amount of the original estimate for each item, the amount due on each item, the gross total, the retained percentage, the amount previously paid and the net amount of payment due.
- 28.02 After final completion and acceptance by the Owner of the entire Work, and when the Contract Price is less than five hundred thousand dollars, the Owner shall issue to the Contractor Certificate of Payment in sum sufficient to increase total payments to ninety percent (90%) of the Contract Price. After final completion and acceptance by the Owner

of the entire Work, and when the Contract Price is five hundred thousand dollars or more, the Owner shall issue to the Contractor Certificate of Payment in sum sufficient to increase total payments to ninety-five percent (95%) of the Contract Price.

- 28.03 When the Contract Price is less than five hundred thousand dollars, the final payment certificate of the remaining ten percent (10%) of the Contract Price, minus any deduction for deficient or Defective Work or other applicable deductions, will be issued by the Owner forty-five (45) days after filing acceptance in the Mortgage Office of the Parish and a Clear Liens and Privilege Certificate has been secured. When the Contract Price is five hundred thousand dollars or more, the final payment certificate of the remaining five percent (5%) of the Contract Price, minus any deduction for deficient or Defective Work or other applicable deductions, will be issued by the Owner forty-five (45) days after filing acceptance in the Mortgage Office of the Parish and a Clear Liens and Privilege Certificate has been secured. Before issuance of the final payment certificate, the Contractor shall deposit with the Owner a certificate from the Clerk of Court and Ex-Officio Recorder of Mortgages from the Parish in which the Work is performed to the effect that no liens have been registered against Contract Work.
- 28.04 When, in the opinion of the Contractor, the Work provided for and contemplated by the Contract Documents has been substantially completed, the Contractor shall notify the Owner in writing that the Work is substantially complete and request a final inspection. The Owner shall proceed to perform such final inspection accompanied by the Contractor. Any and all Work found by this inspection to be Defective or otherwise not in accordance with the plans and Specifications shall be corrected to the entire satisfaction of the Owner and at the sole expense of the Contractor. If the Contract is found to be incomplete in any of its details, the Contractor shall at once remedy such defects, and payments shall be withheld and formal acceptance delayed until such Work has been satisfactorily completed.
- 28.05 If payment is requested on the basis of materials and equipment not incorporated in the Work, but delivered and suitably stored and protected from damage and theft at the site, the Request for Payment shall also be accompanied by such data, satisfactory to the Owner, as will establish Owner's title to the material and equipment and protect its interest therein, including applicable insurance.
- 28.06 Each subsequent Request for Payment shall include an affidavit of Contractor stating that all previous progress payments received on account of the Work have been applied to discharge in full all of Contractor's obligations reflected in prior Request for Payment.
- 28.07 Each subsequent request for payment shall include an affidavit by Contractor that Contractor, all subcontractors, agents, material suppliers and all other persons supplying material to the project upon which State of Louisiana and/or St. Tammany sales taxes are lawfully due have paid these taxes and that all supplies and materials purchased for this project and for which Contractor has been paid have had all lawfully due State and/or St. Tammany sales taxes paid.
- 28.08 The Bid Proposal, unless otherwise modified in writing, and the Contract constitute the complete Project. The Contract Prices constitute the total compensation payable to Contractor and the cost of all of the Work and materials, taxes, permits and incidentals must be included into the Bid submitted by the Contractor and included into those items listed on the Proposal.
- 28.09 Any additional supporting data required by the Owner in order to substantiate Contractor's request for payment shall be furnished by Contractor at no cost to the Owner.
- 28.10 Owner may withhold from payment to Contractor as may be necessary to protect itself from loss on account of:
- (1) Defective and/or inferior work;
 - (2) Damage to the property of Owner or others caused by Contractor;
 - (3) Failure by Contractor to make payments properly to sub-contractors or to pay for labor, materials or equipment used on this project;
 - (4) Failure by Contractor to pay taxes due on materials used on this project;
 - (5) Damage by Contractor to another Contractor;
 - (6) Insolvency;
 - (7) Bankruptcy, voluntary or involuntary;

- (8) Revocation of corporate status;
- (9) Failure to follow corporate formalities;
- (10) Unprofessional activities;
- (11) Unworkmanlike performance;
- (12) Fraud and/or misrepresentation of any kind.

29.00 ACCEPTANCE AND FINAL PAYMENT(S)

- 29.01 Upon receipt of written notice from Contractor that the work is substantially complete and usable by Owner or the Public in suitable manner, the Owner and the Contractor shall jointly inspect the work.
- 29.02 If the Owner by inspection determines that the work is not substantially complete in a suitable manner for use by the Owner or the Public, then the Owner shall so notify the Contractor in writing stating such reason. All reasons need not be disclosed unless actually known. The Owner is afforded an opportunity to amend said notices as are reasonably possible.
- 29.03 If the Owner by its inspection determines that the work is substantially complete, it shall prepare a list of all items not satisfactorily completed and shall notify the Contractor and Owner in writing that the work is substantially complete and subject to satisfactory resolution of those items on the list (punch list). Punch lists may be amended from time to time by Owner in the event that additional deficiencies are discovered. In accordance with LSA-R.S. 38:2248(B), any punch list generated during a construction project shall include the cost estimates for the particular items of work the design professional has developed based on the mobilization, labor, material, and equipment costs of correcting each punch list item. The design professional shall retain his working papers used to determine the punch list items cost estimates should the matter be disputed later. The contract agency shall not withhold from payment more than the value of the punch list. Punch list items completed shall be paid upon the expiration of the forty-five (45) day lien period. The provisions of this Section shall not be subject to waiver.
- 29.04 Upon determination of substantial completeness with the punch list, the Contract Time is interrupted and the Contractor is given a reasonable time not to exceed thirty (30) consecutive calendar days to effect final completion by correcting or completing all of those items listed on the punch list. If the items on the punch list are not completed in a satisfactory manner within the thirty day period, then the Contract Time will begin to run again and will include for purposes of determining liquidated damages the thirty day period the grace period being withdrawn.
- 29.05 Upon receipt by Owner of written determination that all work embraced by the contract has been completed in a satisfactory manner, the Owner shall provide a written acceptance to Contractor who shall record Owner's written acceptance with the recorder of Mortgages, St. Tammany Parish. The Contractor shall properly prepare, submit and pay for all costs associated with said Acceptance. The Contractor is also responsible for preparation, re-submission and payment of any and all updated certificates.
- 29.06 Retainage monies, minus those funds deducted in accordance to the requirements of this agreement including but not limited to Paragraph 28.10, shall be due Contractor not earlier than forty-six (46) calendar days after recordation of certificate of Owner's acceptance provided the following:
- (1) Contractor shall prepare, secure, pay for and submit clear lien and privilege certificate, signed and sealed by Clerk of Court or Recorder of Mortgages, Parish of St. Tammany and dated at least forty-six (46) days after recordation of certificate of acceptance;
 - (2) Ensure that the official representative of the Owner has accepted as per LSA-R.S. 38:2241.1, *et seq.* and that all following sub-sections have been properly satisfied as per law;
 - (3) Ensure that all signatures are affixed and that there exists the requisite authority for all signatures;
 - (4) Ensure accurate and proper legal descriptions;

- (5) Properly identify all parties and/or signatories;
- (6) Properly identify all mailing addresses;
- (7) Correctly set for the amount of the contract, together with all change orders;
- (8) Set out a brief description of the work performed;
- (9) Reference to any previously recorded contract, lien or judgment inscription that may affect the property;
- (10) Certification that substantial completion has occurred, together with any applicable date(s);
- (11) Certification that no party is in default and/or that the project has been abandoned.

29.07 After securing the clear lien and privilege certificate the Contractor shall prepare its final application for payment and submit to Owner. The Owner shall approve application for payment, or state its objections in writing and forward to Contractor for resolution.

30.00 NOTICE AND SERVICE THEREOF

30.01 Any Notice to Contractor from the Owner relative to any part of this Contract shall be in writing and shall be considered delivered and the service thereof completed when said notice is posted; by certified mail, return receipt requested to the said Contractor at its last given address, or delivered in person to said Contractor or its authorized representative on the Work.

31.00 INTENTION OF THESE GENERAL CONDITIONS

31.01 These General Conditions shall be applicable to all contracts entered into by and between the Owner and Contractors, except as may be altered or amended with the consent of the Owner, and/or provided for in the Special Conditions of each contract. Contractor shall be presumed to have full knowledge of these General Conditions which shall be applicable to all contracts containing these General Conditions, whether Contractor has obtained a copy thereof or not.

32.00 SEVERABILITY

32.01 If any one or more or part of any of the provisions contained herein and/or in the Specifications and Contract for the Work shall for any reason be held invalid, illegal or unenforceable in any respect, such invalidity, illegality or unenforceability shall not affect any other provisions of this Agreement or attachment, but it shall be construed as if such invalid, illegal, or unenforceable provision or part of a provision had never been contained herein.

32.02 **CHANGING THESE CONDITIONS:** Owner reserves the right to change or modify these General Conditions as it deems best, or as required by law. The General Conditions may also be modified for a particular project by the use of Special Conditions prior to the issuance of the Advertisement for Bid. However, once an advertisement for bid is made for any specific project, any changes to the General Conditions as they affect that specific project must be made in writing and issued via an addendum in accordance with State Law.

33.00 LAW OF THE STATE OF LOUISIANA

33.01 The Contract Documents shall be governed by the Law of the State of Louisiana.

33.02 The Contractor agrees to pay reasonable attorney's fees and other reasonable attendant costs, in the event that it becomes necessary for the Owner to employ an attorney in order

to enforce compliance with or any remedy relating to any covenants, obligations, or conditions imposed upon the Contractor by this Agreement. Attorney fees shall be based upon the prevailing hourly rate of attorney rates in the private sector. In no case shall the hourly rate be less than \$175.00 per hour. All attorney fees collected shall be paid the operating budget of the Office of the Parish President.

- 33.03 The jurisdiction and venue provisions shall apply to all contractors, sureties, and subcontractors. The 22nd Judicial District for the Parish of St. Tammany shall be the court of exclusive jurisdiction and venue for any dispute arising from these General Conditions and/or any contract executed in conjunction with these General Conditions. All parties specifically waive any rights they have or may have for removal of any disputes to Federal Court, or transfers to different State District Court.
- 33.04 Contractor warrants that it has and/or had received a copy of these General Conditions at all times material hereto; Contractor further agrees that it has read and fully and completely understands each and every condition herein.
- 33.05 The property description will be more fully set out by an attached exhibit.
- 33.06 The Contractor warrants that it has the requisite authority to sign and enter this agreement.
- 33.07 It is specifically understood and agreed that in the event Contractor seeks contribution from the Parish or pursues its legal remedies for any alleged breach of this agreement by the Parish, then the following list of damages SHALL NOT BE RECOVERABLE BY CONTRACTOR. This list includes, but is not limited to:

1. indirect costs and/or expenses;
2. direct costs and/or expenses;
3. time-related costs and/or expenses;
4. award of extra days;
5. costs of salaries or other compensation of Contractor's personnel at Contractor's principal office and branch offices;
6. expenses of Contractor's principal, branch and/or field offices;
7. any part of Contractor's capital expenses, including any interest on Contractor's capital employed for the work;
8. any other charges related to change orders;
9. overhead and general expenses of any kind or the cost of any item not specifically and expressly included in Cost of Work.

33.08 DEFAULT AND WAIVERS

It is understood that time is of the essence. It is specifically understood between the parties that Contractor waives any and all notice to be placed in default by the Owner. This subsection shall supersede and prime any other subsection herein above that is in conflict. The Owner specifically reserves its right and specifically does not waive the requirement to be placed in default by the Contractor as per law.

- 33.09 St. Tammany Parish Government contracts to be awarded are dependent on the available funding and/or approval by members designated and/or acknowledged by St. Tammany Parish Government. At any time St. Tammany Parish Government reserves the right to cancel the award of a contract if either or both of these factors is deficient.
- 33.10 It is the Parish's policy to provide a method to protest exclusion from a competition or from the award of a contract, or to challenge an alleged solicitation irregularity. It is always better to seek a resolution within the Parish system before resorting to outside agencies and/or litigation to resolve differences. All protests must be made in writing, and shall be concise and logically presented to facilitate review by the Parish. The written protest shall include:
1. The protester's name, address, and fax and telephone numbers and the solicitation, bid, or contract number;
 2. A detailed statement of its legal and factual grounds, including a description of the resulting prejudice to the protester;

3. Copies of relevant documents;
4. All information establishing that the protester is an interested party and that the protest is timely; and
5. A request for a ruling by the agency; and a statement of the form of relief requested.

The protest shall be addressed to Director of Procurement, St. Tammany Parish Government, P.O. Box 628, Covington, LA 70434.

The protest review shall be conducted by the Parish Procurement Department.

Only protests from interested parties will be allowed. Protests based on alleged solicitation improprieties that are apparent before bid opening, or the time set for receipt of initial proposals must be filed with and received by the Procurement Department BEFORE those deadlines.

Any other protest shall be filed no later than ten (10) calendar days after the basis of the protest is known, or should have been known (whichever is earlier).

The Parish will use its best efforts to resolve the protest within thirty (30) days of the date that it is received by the Parish. The written response will be sent to the protestor via mail and, fax, if a fax number has been provided by the protestor. The protestor can request additional methods of notification.

Last day to submit questions and/or verification on comparable products will be no later than 2:00 pm CST, seven (7) working days prior to the opening date of the bid/proposal due date. Further any questions or inquires must be submitted via fax to 985-898-5227, or via email to Purchasing@stpgov.org. Any questions or inquires received after the required deadline to submit questions or inquires will not be answered.

Section 09

Contract Time Extension Specifications

The contractor shall document for each month of the scheduled construction, the occurrence of adverse weather conditions having an impact on controlling items of work. An adverse weather day is a previously scheduled or normally scheduled work day on which rainfall, wet conditions or cold weather will prevent construction operations on the controlling work activity from proceeding for at least five (5) continuous hours of the day or sixty-five (65) percent of the normal work day, whichever is greater, with the normal working force engaged in performing the controlling item of work.

If the contractor submits a written request for additional contract time due to adverse weather conditions, the contractor's request will be considered only after the Department agrees with the days and then only for adverse weather days in excess of allowable number of days per month stated below. Adverse weather days will be documented by the Engineer and agreed upon monthly. Adverse weather days will be prorated for partial months when a work order or final inspection is issued other than the first or last of the month and agreed to by the Department.

If the contractor is being considered for disqualification by the department, an equitable adjustment in contract time may be made at the end of the original contract period, including all days added by approved change orders.

Contract time will be adjusted by comparing the actual number of adverse weather days to the statistical number of adverse weather days over the specific time period per the table below. The resulting number of adverse weather days will be multiplied by 1.45 to convert the calendar days.

Adjustments for adverse weather cannot result in a contract time reduction. Once adjusted, a new adverse weather day accounting will begin using the adverse weather conditions having an impact on the controlling items of work, in excess of the allowable number of days per month stated below. A second and final contract time adjustment will be done at the final acceptance of the project.

An adjustment in the contract time due to adverse weather will not be cause for an adjustment in the contract amount. There will be no direct or indirect cost reimbursement for excess adverse weather days.

The following are anticipated adverse weather days that the contractor shall include in each month of his calendar day construction schedule.

January	10 days	May	5 days	September	4 days
February	9 days	June	6 days	October	3 days
March	8 days	July	6 days	November	7 days
April	7 days	August	5 days	December	7 days

FIBER-REINFORCED PORTLAND CEMENT CONCRETE ROADWAYS

This item covers the furnishing of all materials and installation of PCC roadway pavements for thickness as shown.

Mix for 1 C.Y. of Fiber-Reinforced Concrete – Sidewalks & Driveways

28-day strength	4000 psi
Cement (ASTM C-150, Type I/II)	4.64 sacks (436 lbs.)
Fly Ash (ASTM C-618)	1.16 sacks(109 lbs.)
Gravel (ASTM C-33, Grade A)	1775 lbs.
Sand (ASTM C-33)	1226 lbs.
Water (potable)	30 gallons (250 lbs.)
Type A Water Reducer (ASTM C-494)	16.35 lbs.
Air entrainment specifications	5% by volume, use per manufacturers specifications
Fiber reinforcement	1.5 lbs/ CY microfibers, as specified below

Fiber reinforcement for all concrete pavements shall be Matrix Monofilament Microfiber as manufactured by FRC Industries or approved equal, applied throughout the concrete mixture. Alternate products must be preapproved by the City Engineer in writing. Cellulose (treated or untreated), AR glass, nylon, and polyester fibers are specifically prohibited from use. Fibrillated and self-fibrillating fibers are also specifically prohibited.

Fiber reinforcement shall be applied **at the plant**. The bags must be broken before mixing. Bag size shall be one (1) pound.

Damaged, missing, and/ or new dowel bars (longitudinal/ transverse) and Starlugs shall be replaced, 1-1/8" x 18" painted smooth dowel bars on 12" centers shall be used unless directed otherwise by the City Engineer. The bars shall be drilled and doweled into the existing pavement by drilling 1½" holes to a depth of 9" and filling with an approved epoxy grout before insertion of the dowel bars. Any deformed bars for longitudinal joints or welded wire fabric will be incidental to the bid unit prices under this item. All costs incurred for this task will be incidental to bid unit prices under concrete paving. Bid prices shall also include adequate curing of the concrete placed and the proper sealing of contraction and expansion joints.

The Contractor is advised that the work along roadways will necessarily be done with a split-paving method. It will be important to have at least one side of the roadway open to traffic when workers are not present.

Bid prices should include all costs for labor, equipment, and materials necessary to provide finished Portland Cement Concrete paving, in place, as described under this item of the proposal. All required jointing materials should be included in price bid under each item. Method of jointing shall be the same as the existing joints in the area of work.

Bid prices under this item shall also include cost of providing engineering/ surveying for alignment, grade, profile, survey stakes, and topography when necessary and as required to improve the roadway alignment, curb and gutter layout, drain line installation, etc. Compensation for this shall be incidental to corresponding bid items in the maintenance contract. There is no other compensation. This includes new road, extension of existing road, and turning lanes, parking lots, bike, and walking trails, etc. All layouts shall be the responsibility of the contractor. The Contractor shall be responsible for disposal of all construction materials.

Concrete pavement shall be cured seven (7) days unless otherwise approved by the City Engineer. If Contractor uses "high early" strength concrete (3-day curing period) at his discretion, without the approval of the City Engineer, payment shall be made under the regular (7-day curing) concrete paving item. Contractor shall be responsible for proper oversight and protection of the pavement during the initial curing time until the concrete is sufficiently set to resist marring or vandalism.

**ST. TAMMANY PARISH ROADWAY TESTING & INSPECTION
STANDARDS FOR RESIDENTIAL SUBDIVISION**

GENERAL:

- Louisiana Standard Specifications for Roads and Bridges (LSSRB), as amended, special provisions by the St. Tammany Parish Roadway Design and Construction Standards shall apply to Roadway Testing and Inspection Requirements.
- Testing of all materials and construction shall be in accordance with ASTM, AASHTO or LA DOTD specifications.
- All testing and inspection reports performed by the independent testing laboratory employed by the developer/contractor shall be submitted to the Parish Engineering Department within 10 working days after the tests are conducted.
- Materials Testing Laboratories should be approved by St. Tammany Parish Engineering Department. The testing and inspection firm must have a minimum of 5 years of experience and operates under the direct supervision of a Louisiana Registered Professional Engineer.

1. Roadway Subgrade Preparation

The roadway alignment should be stripped of all topsoil with organics and other deleterious materials. The topsoil in St. Tammany Parish is generally underlain by moisture sensitive silty soils. These near surface silty deposits should be examined at the time of construction since they tend to lose their support capabilities if they become wet. Consequently, depending on the site condition at the time of construction, the moisture sensitive soils may have to be undercut and replaced with compacted structural fill.

Once the roadway alignment is stripped and undercut to the required subgrade elevation, the roadway subgrade should be proofrolled using a single or a tandem axle dump truck or similar heavily loaded rubber tired vehicle weighing about 20 tons. Soils which are observed to rut or deflect under the moving load should be undercut and replaced with compacted structural fill, disked open to dry or treated to form a stable non-yielding subgrade prior to fill placement. Proofrolling the roadway subgrade should be witnessed by St. Tammany Parish Inspection personnel or their representative prior to proceeding with fill placement. The approval of the subgrade is valid for 24 hours. Therefore, the subgrade should be protected and covered with fill as soon as possible. Should the subgrade be exposed to excessive amount of precipitation, re-approval of the subgrade will be required.

2. Roadway Fill

Fill placed along the roadway alignment should consist of sandy clays, clayey or silty sands free of organics and other deleterious materials. The fill should have a maximum liquid limit of 40 and a plasticity index less than 18 percent. The structural fill should be placed in maximum lifts of 8 inches of loose materials and should be compacted within 1 percentage point below to 3 percentage points above the optimum moisture content. The fill should be compacted to at least 95 percent of the fill's maximum dry density as determined by ASTM D698 (AASHTO T99). Each lift of fill should be compacted by the parish designated testing laboratory and approved prior to placement of subsequent lifts. The edge of the fill should extend at least 2 feet beyond the edge of the road or face of curb. Field density tests should be conducted in accordance with ASTM D2922 at 100 foot intervals along the roadway alignment.

3. Aggregate Base Course

The roadway aggregate base should consist of Class II Base including 610 limestone or crushed concrete meeting the requirements of the latest edition of Louisiana Standard Specifications for Roads and Bridges (LSSRB), Section 1003.3D. The aggregate base should be compacted to at least 95 percent of the aggregate's maximum dry density determined by ASTM D698 (AASHTO T99). Field density tests should be conducted on the base material in accordance with ASTM D2922 at 100 foot intervals along the roadway alignment. In addition, depth checks should be conducted at the density test locations to verify compliance with the pavement design and parish requirements.

4. Lime Treated Subgrade

Lime treatment may be used to stabilize the clay subgrade or to dry the in situ soil. It is not intended for use as a pavement base. Lime treatment should be conducted after the soil has been classified and the plasticity index of the soil is determined to optimize the quantity of lime needed to treat the soil. The following percent of hydrated lime, by weight, is a guide to treat the cohesive soil. The actual amount shall be verified prior to field application.

% of Hydrated Lime by Weight	Clay Soil Plasticity Index, %
2	18 to 30
4	31 to 45

The percent of lime required to stabilize clays with plasticity indices over 45 percent shall be determined by an independent testing laboratory. Lime treatment of silty soils should be conducted for drying purposes only.

Lime treatment should be designated by type in accordance with LSSRB, Section 304. When lime is used to treat the clay sub-base or to prepare for cement treatment, Type B and Type C shall be used, respectively. For Type B and Type C treatments, the pulverized treated soil should yield 95 percent passing the ¾ inch sieve and 50 percent passing the No. 4 sieve, by weight. The mixture should be compacted to at least 95 percent of the maximum dry density as determined by ASTM D698 (AASHTO T-99). Field density tests should be conducted at intervals of 200 linear feet of roadway. The mixture should be protected against drying in accordance with LA DOTD specifications.

5. Cement Treated Base

Cement treatment of roadways should be conducted in general accordance with LSSRB, Section 303. Cement treated base generally involves treatment of the existing subgrade soils or treatment of imported embankment fill to be used as a base course in flexible or rigid pavement sections.

The in situ or embankment fill considered for cement treatment should have a plasticity index of less than 15 percent. Soils with higher plasticity indices should be lime treated prior to cement treatment. Cement treated bases for roadways should be designed to yield a minimum compressive strength of 300 psi at 7 days as determined by a mix design in accordance with DOTD TR 432 Standard Procedure. The mix design should be conducted on representative samples of the subgrade soil by an independent testing laboratory. Unless the results of the mix design indicate otherwise, the silty soils encountered generally in St. Tammany Parish should be treated with at least 10 percent of Portland Cement, by volume. The roadway should be prepared in general accordance with LSSRB, Section 303-04. The moisture content of the mixture should be within 2 percent of the optimum moisture at the time of treatment. Pulverization of the treated soils should yield a mixture with at least 60% passing the No. 4 sieve.

Compaction and finishing of a treated roadway section should be completed within 3 hours of the initial cement application to the base course materials. The treated base should be compacted to at least 95 percent of the mixture's maximum dry density as determined by ASTM D698 (AASHTO T-99). Field density tests should be conducted on the cement treated base at a frequency of not less than 1 test per 100 linear feet of road.

Thickness of the cement treated base should be verified for compliance with the roadway design. The depth of treatment should be checked during placement at a frequency of not less than 1 test per 100 linear feet of road. The cement treated base should be immediately protected against rapid drying by applying an asphalt curing membrane. The treated section should be allowed to cure for a period of at least 7 days prior to exposure to construction traffic. The contractor should protect the treated base from damage until the surface course is placed. Damaged base course should be repaired by the contractor and approved by St. Tammany Parish Engineering Department prior to application of the surface course.

6. Portland Cement Concrete

Portland Cement Concrete for St. Tammany Parish roadways should be placed on approved roadway bases. The concrete mix design should be reviewed in accordance with ACI 301 for compliance with the strength requirements. All materials used in the concrete mix should be from DOTD approved sources. The materials should be proportioned, batched, cured and placed in accordance with LSSRB, Section 901.

Prior to placement of concrete, depth checks should be conducted by string lines trained across the forms to verify the pavement thickness at a frequency of not less than 50 feet. Deficiencies noted should be corrected and approved prior to concrete placement.

During placement of Portland Cement Concrete pavement, observation and testing should be done on a full-time basis. At a minimum slump, air content and mix temperature test should be conducted every 50 yards of placed concrete. Four (4) compressive strength cylinders should be cast every 100 cubic yards placed. Cylinders shall be tested as follows: 1 Cylinder at 7 days, 2 cylinders at 28 days and 1 cylinder should be placed on hold. Additional cylinders should be cast when high/early mix is used and early concrete strength is required to open the road to traffic with the approval of St. Tammany Parish Engineering Department. The placed concrete should be finished, cured and protected in accordance with LSSRB requirements. At the discretion of St. Tammany Parish Engineering Department, cores may be obtained for verification of pavement thickness.

7. Asphaltic Concrete

All materials used in the mixture should be from DOTD approved sources. The materials should be proportioned to produce a pavement mix meeting LSSRB requirements. The proposed mix design should be submitted for approval to St. Tammany Parish Engineering Department. The asphaltic concrete mixture should be placed on a stable and approved base.

During placement of asphaltic concrete, observation and testing shall be on a full-time basis. For each 1,000 tons of materials placed, or a fraction thereof in one day, a sample should be tested at the plant for percent void, Void Mineral Aggregate (VMA), asphalt content and gradation. The results will be used to control the mixture and form a basis for acceptance of the pavement.

Mix temperature should be checked on each truck load in the field. Loads with low temperatures not meeting specifications should not be placed.

The final pavement thickness and density of the mixture shall be verified by obtaining 4 inch diameter cores at a minimum frequency of 1 core per 400 linear feet of road and not less than 3 cores per roadway section. The density of the pavement core should not be less than 92 percent of the maximum theoretical density. The thickness of the cores should be within ¼ inch of the design thickness. The Parish reserves the right to accept or reject the pavement based on the test results.

8. Utility Trench Backfill

Backfill material for culverts and storm drains should be placed and compacted in general accordance with LSSRB, Section 701, as modified in this section.

Cross drains and side drains in paved areas should be backfilled with granular fill A-3 material or better. The backfill shall be placed near optimum moisture and should be compacted in lifts not exceeding 12 inches. Field density tests should be performed during the backfill operation from 1 foot above the pipe up to the finished grade. Each layer should be compacted to 95 percent of the fill's maximum dry density as determined by ASTM D698 (AASHTO T-99). The field density tests should be conducted at a minimum frequency of 1 test per 100 linear feet.

Bedding material should be provided under the utility lines with a minimum of 6 inches placed under the pipe and extending one half of the pipe diameter beyond the edge of either side of the pipe or minimum of 12 inches, whichever is greater. The pipe should be side bedded to the mid-height of the pipe or to the pipe spring line, if arch pipe is used. The bedding material should consist of free draining granular material meeting the requirements of #57 limestone or crushed concrete. Other bedding materials may be considered by St. Tammany Parish Engineering Department. A geotextile fabric should also be placed around the pipe at each joint to reduce potential migration of the fill into the joints of the pipe.

Utility trench backfill in non paved areas should be either granular material or selected soils as defined by LSSRB, Section 701.08. The fill should be compacted in lifts to the density of the surrounding soil but not less than 90 percent of the fill's maximum dry density as determined by ASTM D698 (AASHTO T-99).



TESTING RECORD

Minimum Testing Requirements for Roadways

Project Number _____ Road _____ Date _____

Project Inspector _____ Location Description _____

Item	Type of Test/Method	Min Testing Frequency	Required # of Tests	Actual # of Tests
Roadway Subgrade	Proof roll (tandem axle, 20 tons)	All Subgrade		
String Line Depth Check	Depth Check	Test/50 LF		
Roadway Base	Field Moisture/Density, DOTD TR401	1 Test/100LF/Lift		
	Depth Check	1 Test/100 LF		
	Laboratory Moisture/Density, ASTM D698 or DOTD TR418. Required 95%	1Test/Aggregate Type		
	Sieve Analysis, ASTM C136 or DOTD TR113	1 Test/Aggregate Type		
Lime Treated Subgrade	Lime Series, DOTD TR416	1 Test/Soil Type		
	Field Moisture/Density, DOTD TR401	1 Test/1000 LF		
Cement Treated Base	Soil/Cement Series, DOTD TR432	1 Test/Soil Type		
	Field Moisture/Density (1 point proctor – family of curves) DOTD TR415	Daily/Treated Section		
	Field Moisture Density, ASTM D2922 or DOTD TR401	1 Test/1000 LF		
	Depth Check	1 Test/100 LF		
Roadway Concrete	Slump, ASTM C143	1 Test/50 CYDS or fraction thereof		
	Temperature, ASTM C1064	1 Test/50 CYDS or fraction thereof		
	Air Content, ASTM C231 or C173	1 Test/50 CYDS or fraction thereof		
	Test Cylinders, ASTM C31	1 set of 4 Cylinders/100 CYD or fraction thereof		
Roadway Asphalt	Field Temperature- Parish Inspector	Full-Time/Every Load		
	Laboratory Extraction and Gradation, DOTD TR323 and TR309, Marshall Stability, DOTD TR305, Specific Gravity, TR304 or AASHTO M323 (Super Pave)	1 Test/500 Tons or a Fraction Thereof/day or if less: 2 tests per day, 1 per ½ day.		
Roadway Cores	Thickness and Density	3 Cores/1000 Feet		
Utility Trench Bedding	Gradation, ASTM C136 or DOTD TR113	1 Test/Aggregate Type		
Utility Trench Backfill	Classification, ASTM D2487 or DOTD TR423	1 Test/Soil Type		
	Laboratory Moisture/Density, ASTM D698 or DOTD TR418	1 Test/Soil Type		
	Field Moisture/Density, ASTM D2922 or DOTD TR401	1 Test/100 LF/Lift		

ROLLOVER CURB DETAIL

St. Tammany Parish Department of Engineering
P.O. Box 625, Covington, La. 70344
Phone: 8849 888-3352 Fax: 8849 488-3359
Toll Free: 800 837-3110

04-09-14
NTS

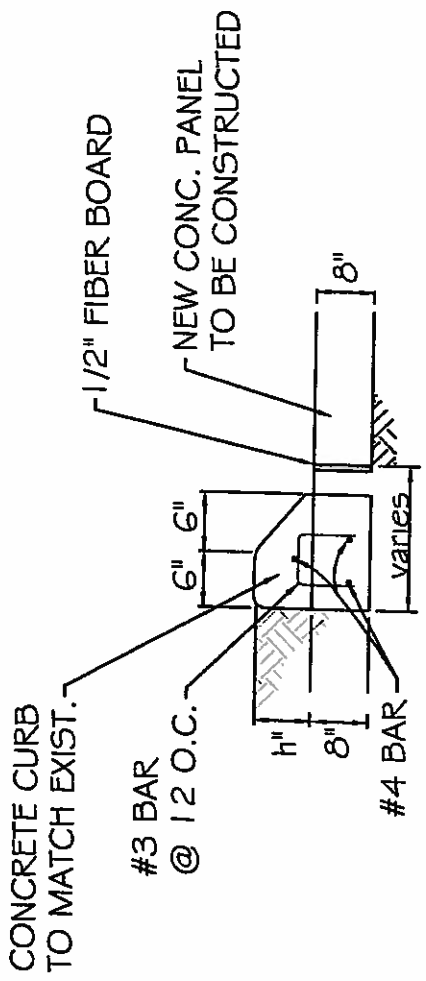

$h(IN.)$ = HEIGHT VARIES ACCORDING TO SURROUNDING LAND ELEVATIONS OR EXISTING CURB HEIGHT

* MIN. 3" COVER FOR ALL REBAR

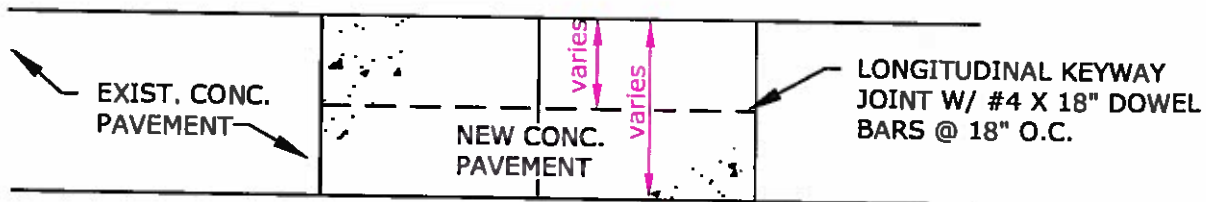

PLAN VIEW

NTS

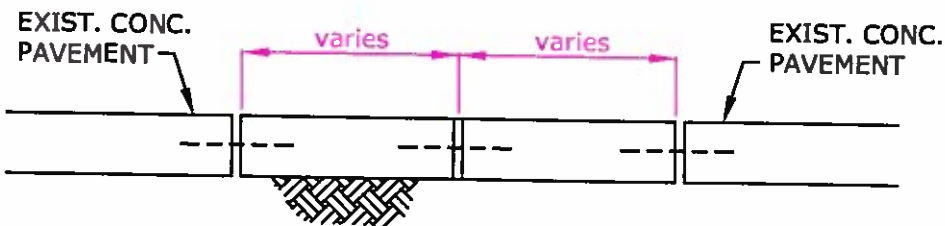

- * BASE MATERIAL TO BE EXAMINED BY PROJECT INSPECTOR PRIOR TO INSTALLATION OF FORMS.
- * AS NECESSARY OR DIRECTED, THE CONTRACTOR SHALL REMOVE & REPLACE ALL UNSUITABLE BASE MATERIAL 12" BELOW GRADE OF NEW 8" THICK CONCRETE PANEL; THIS MAY BE THE ENTIRE AREA OF PANEL (NO DIRECT PAY)
- * REPLACE JOINTS IN KIND, ie, EXPANSION JT, CONTROL JT., ETC.

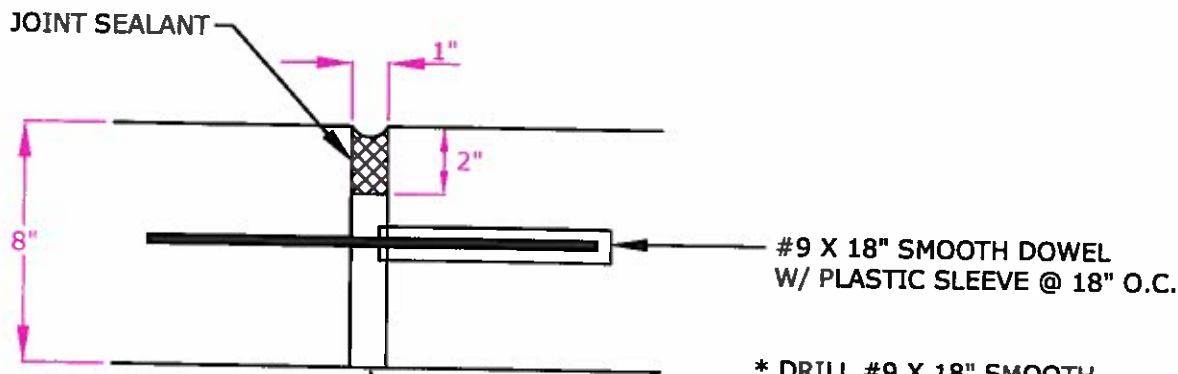

* 4000 PSI PORTLAND CEMENT CONCRETE PAVEMENT

PREFORMED EXPANSION JOINT FILLER

* DRILL #9 X 18" SMOOTH DOWEL BARS INTO EXISTING CONCRETE PAVEMENT @ 18" O.C.

Project No.	1
Date	04-09-14
Sheet	NTS
Page	1



Rev. No.	Date	Description

CONCRETE PAVEMENT REPLACEMENT DETAIL

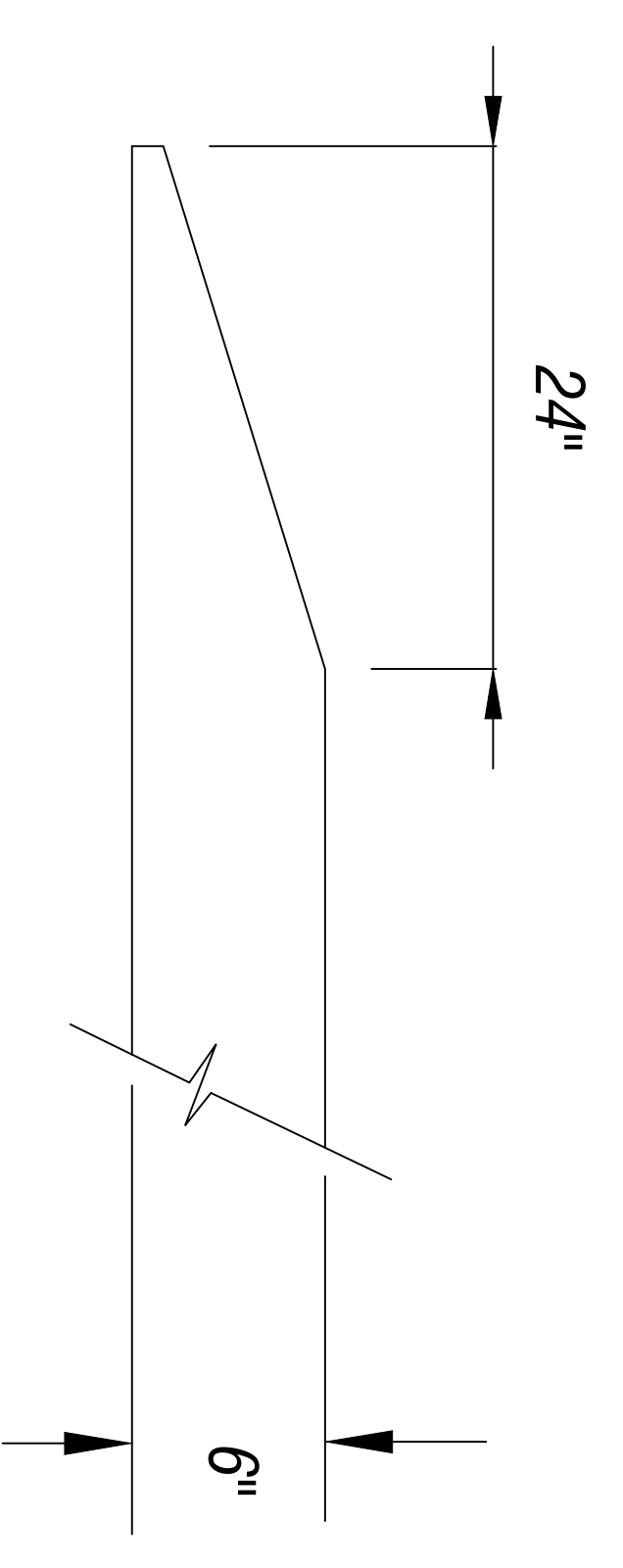
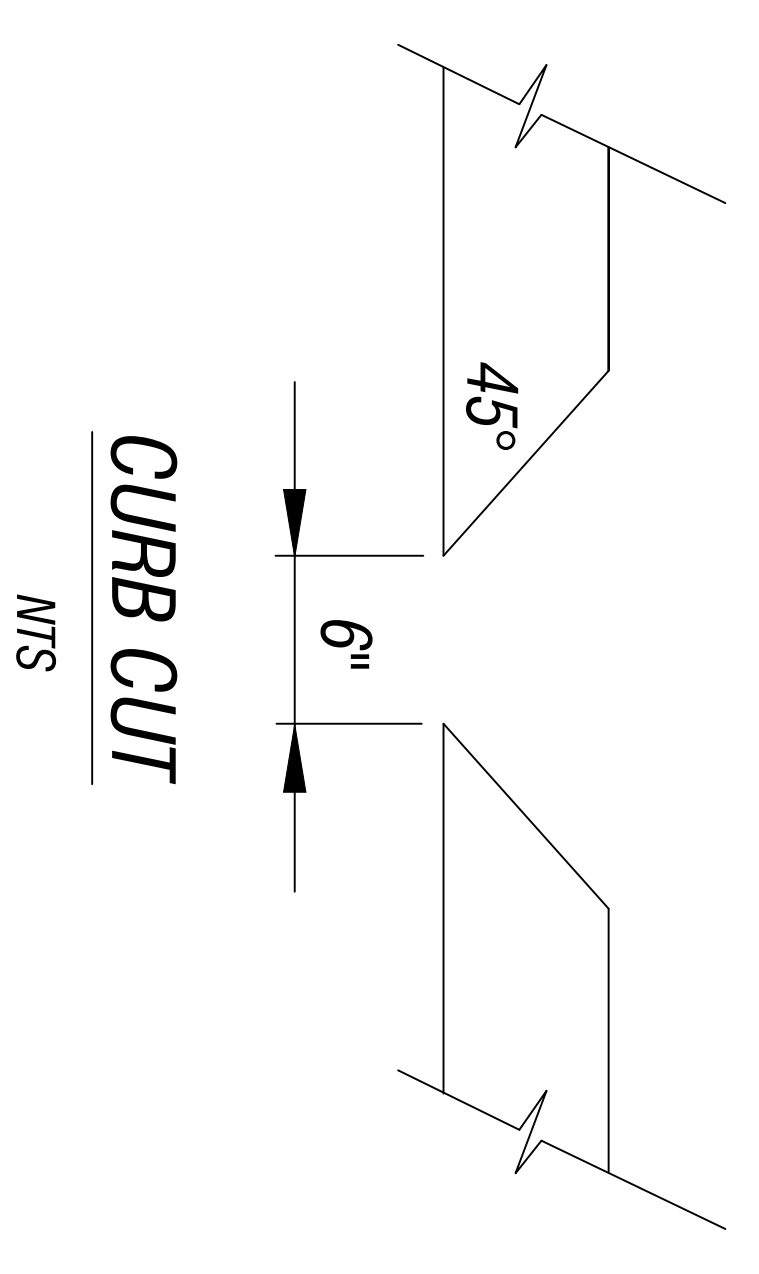
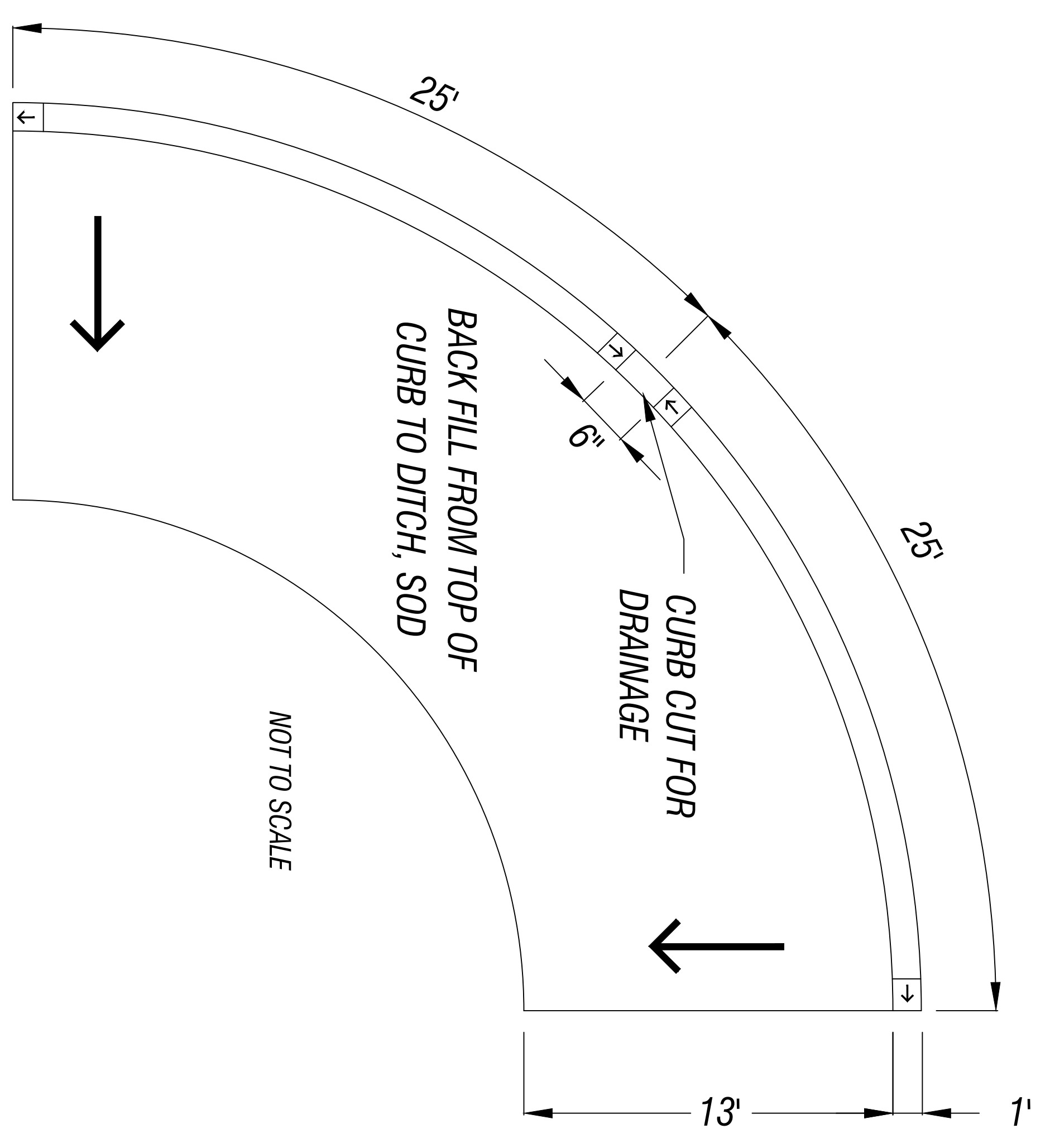
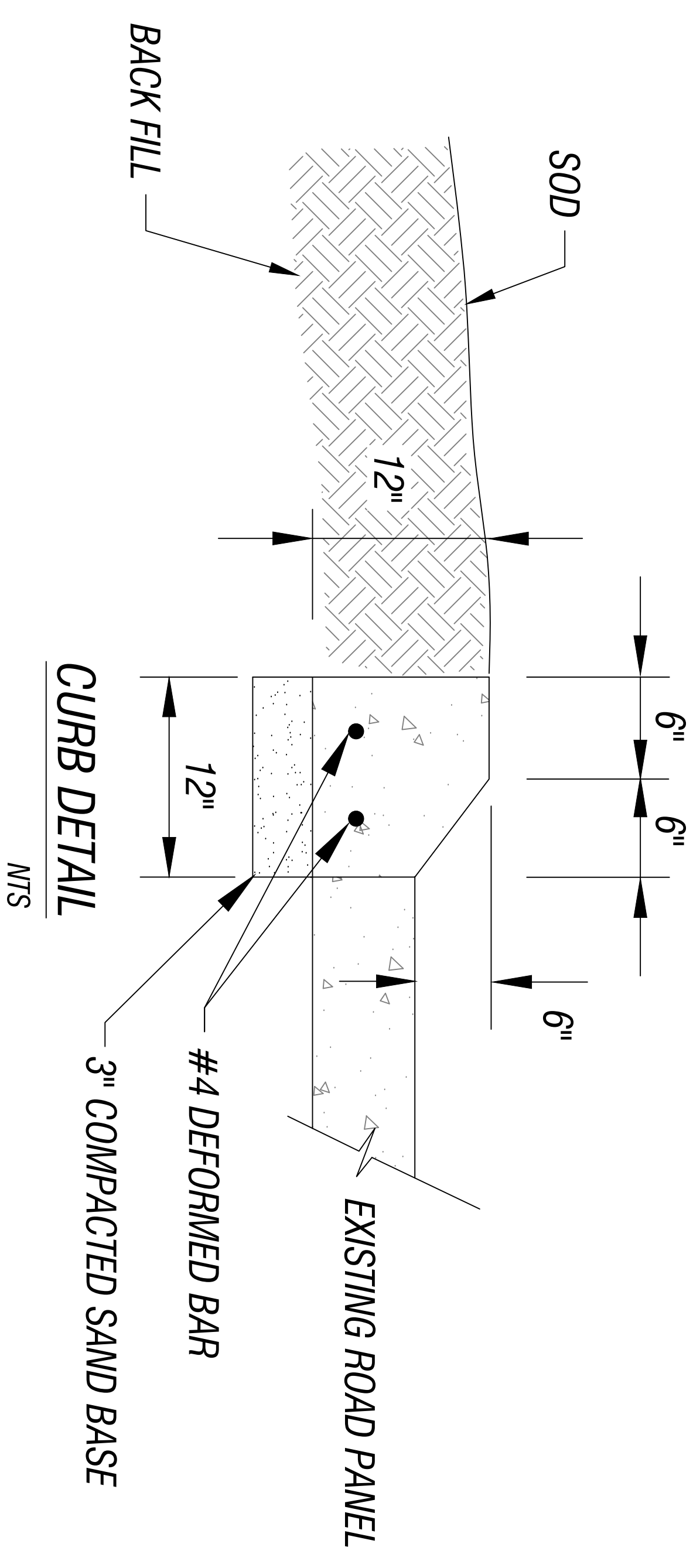

Project No.	Sheet
Date 04-18-2017	1
Scale NTS	
Drawn By	

 St. Tammany Parish Department of Engineering
 P.O. Box 628 Covington, La. 70434
 Phone: (985) 898-2552 Fax: (985) 898-5205
 Fax: (985) 867-5110

Rev. No.	Date	Description

CURB AND PANEL IMPROVEMENTS

PLAN VIEW
ROADWAY SHOWING JOINTS

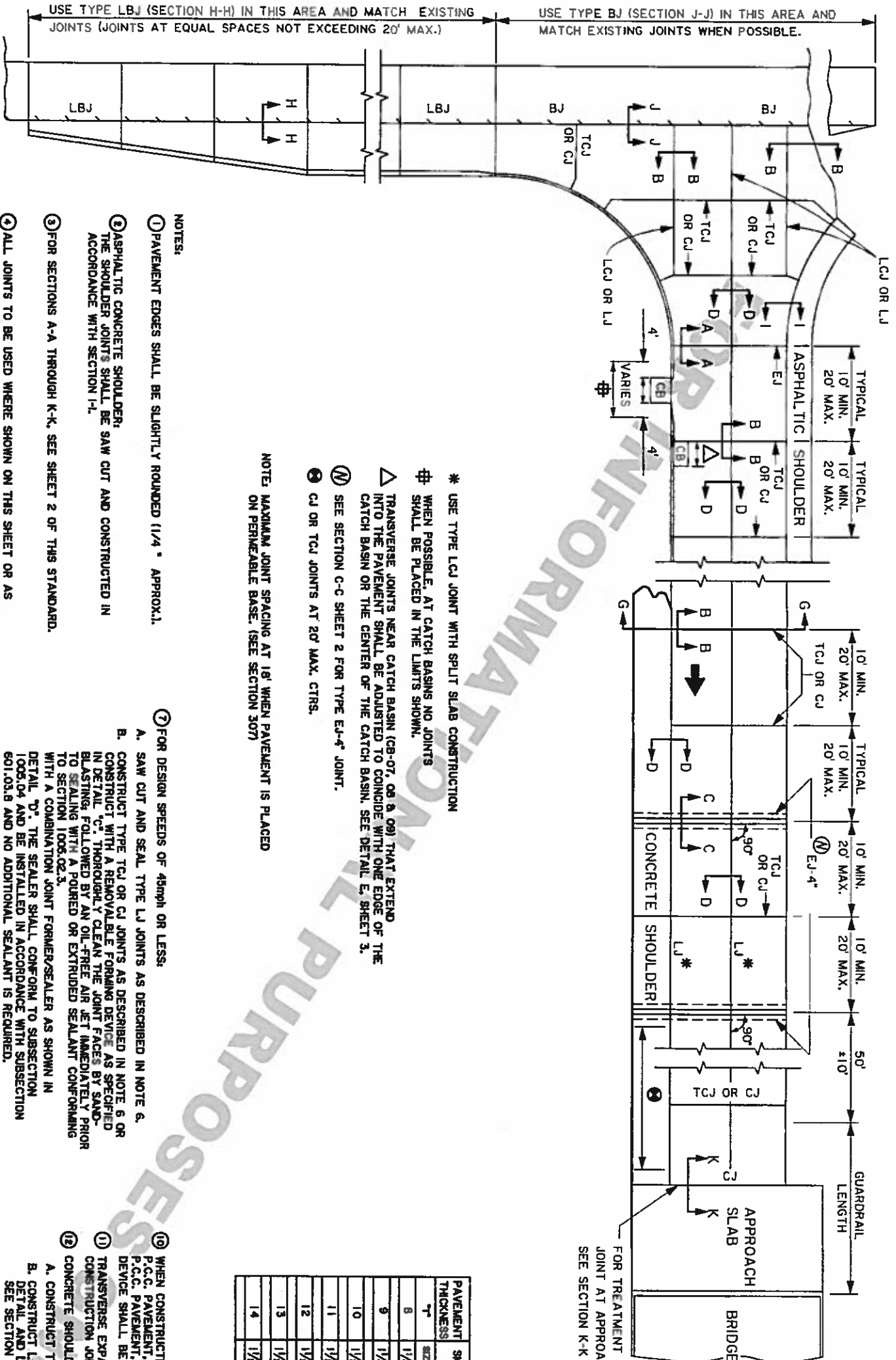

JOINT LEGEND:
 L.J: LONGITUDINAL JOINT
 E.J: TRANSVERSE EXPANSION JOINT
 T.C.J: TRANSVERSE CONTRACTION JOINT
 C.J: CONTRACTION JOINT
 L.C.J: LONGITUDINAL CONSTRUCTION JOINT
 L.B.J: LONGITUDINAL BUTT JOINT
 B.J: TRANSVERSE BUTT JOINT

FOR TREATMENT OF CJ JOINT AT APPROACH SLAB SEE SECTION K-K SHEET 2.

TABLE 1
ALL DIMENSIONS ARE IN INCHES

PAVEMENT THICKNESS	SMOOTH DOWEL BARS	DEF. TIE BARS	KEYWAY
7"	SIZE LENGTH SPACING	SIZE LENGTH SPACING	1/4" x 1/4"
8	1 1/2" 18" 12"	1/2" 24" 24"	2 1/2" x 1 1/4"
9	1 1/2" 18" 12"	1/2" 24" 24"	2 1/2" x 1 1/4"
10	1 1/2" 18" 12"	1/2" 24" 24"	2 1/2" x 1 1/4"
11	1 1/2" 18" 12"	3/4" 30" 24"	2 1/2" x 1 1/4"
12	1 1/2" 18" 12"	3/4" 30" 24"	3" x 1 1/2"
13	1 1/2" 18" 12"	3/4" 30" 24"	3" x 1 1/2"
14	1 1/2" 18" 12"	3/4" 30" 24"	3" x 1 1/2"

- NOTES:
- PAVEMENT EDGES SHALL BE SLIGHTLY ROUNDED (1/4" APPROX.).
 - ASPHALTIC CONCRETE SHOULDER: THE SHOULDER JOINTS SHALL BE SAW CUT AND CONSTRUCTED IN ACCORDANCE WITH SECTION I-L.
 - FOR SECTIONS A-A THROUGH K-K, SEE SHEET 2 OF THIS STANDARD.
 - ALL JOINTS TO BE USED WHERE SHOWN ON THIS SHEET OR AS SHOWN ELSEWHERE IN THE PLANS OR AS OTHERWISE DIRECTED BY THE ENGINEER.
 - FOR DESIGN SPEEDS OF 45mph OR LESS:
 - SAW CUT AND SEAL TYPE L.J JOINTS AS DESCRIBED IN NOTE 6.
 - CONSTRUCT TYPE T.C.J OR C.J JOINTS AS DESCRIBED IN NOTE 6 OR CONSTRUCT WITH A REMOVABLE FORMING DEVICE AS SPECIFIED IN DETAIL 'C'. THOROUGHLY CLEAN THE JOINT FACES BY SAND-BLASTING FOLLOWED BY AN OIL-FREE AIR JET IMMEDIATELY PRIOR TO SEALING WITH A Poured OR EXTRUDED SEALANT CONFORMING TO SECTION 1005.02.3.
 - WITH A COMBINATION JOINT FORMER/SEALER AS SHOWN IN DETAIL 'D'. THE SEALER SHALL CONFORM TO SUBSECTION 1005.04 AND BE INSTALLED IN ACCORDANCE WITH SUBSECTION 601.03.8 AND NO ADDITIONAL SEALANT IS REQUIRED.
 - EXCEPT AS NOTED BELOW, DOWEL BARS & TIE BARS SHALL BE HELD IN PLACE BY SUPPORTS SIMILAR TO THE ONES SHOWN, OR APPROVED EQUALS. APPROVED MECHANICAL PLACEMENT OF DOWEL BARS AND TIE BARS WILL BE ALLOWED WITH ALL PAVING METHODS. WHEN DOWEL BAR BASKETS ARE USED, APPROXIMATELY THE CENTER "T" OF SPACER WIRE, THAT SPAN ACROSS THE JOINT, SHALL BE CLIPPED AND REMOVED AFTER STAKING BASKETS IN PLACE.
 - INSTALL GEOTEXTILE FABRIC (TYPE B, C, OR D) UNDER ALL T.C.J, C.J, AND E.J ALTERNATE JOINTS WHEN CONCRETE PAVEMENT IS PLACED ON MECHANICALLY IMPLANTED, THE GEOTEXTILE FABRIC SHALL BE ANCHORED TO THE BASE COURSE WITH PINS.
 - TIEBARS SHALL NOT BE PLACED WITHIN 18" OF CONTRACTION OR EXPANSION JOINTS.
 - WHEN CONSTRUCTING CONCRETE CURB AND GUTTER ADJACENT TO NEW P.C.C. PAVEMENT, USE TYPE L.C.J JOINT. WHEN ADJACENT TO EXISTING P.C.C. PAVEMENT, USE TYPE L.B.J JOINT. THE FIRST LOAD TRANSFER DEVICE SHALL BE INSTALLED 18" FROM THE PAVEMENT EDGE.
 - TRANSVERSE EXPANSION JOINTS ARE NOT TO BE USED FOR CONSTRUCTION JOINTS.
 - CONCRETE SHOULDERS:
 - CONSTRUCT T.C.J JOINTS IN ACCORDANCE WITH SECTION B-B.
 - CONSTRUCT L.C.J JOINTS IN ACCORDANCE WITH TYPE L.C.J DETAIL AND L.J JOINTS IN ACCORDANCE WITH TYPE L.J DETAIL. SEE SECTION D-D.
 - USE THE MAXIMUM SHOULDER THICKNESS WHEN DETERMINING DOWEL BAR AND TIE BAR SIZES IN TABLE 1.
 - WHEN SKEWED JOINTS ARE USED ON MAINLINE PAVING THE SHOULDER T.C.J JOINTS MAY BE SKEWED OR CONSTRUCTED AT 90°.
 - SHOULDER JOINTS AND JOINT MATERIALS SHALL MATCH THE MAIN LINE.
 - HEIGHT OF DOWEL BASKET SHALL BE BASED ON THE THINNEST SHOULDER THICKNESS. VARYING HEIGHT DOWEL BASKETS WILL BE ALLOWED TO KEEP THE DOWEL BAR LOCATED WITHIN TOLERANCE.

NOT TO SCALE

PORTLAND CEMENT
CONCRETE PAVEMENT
DETAILS

CP-01



DATE	REVISION DESCRIPTION	BY
APPROVED BY	DATE	6/3/13
CHIEF ENGINEER		

DESIGNED: GLF	CHECKED: CW	PARISH
DETAILED: GLF	CHECKED: ICW	CONTROL SECTION
DATE SHEET	03/04/2013 OF 3	STATE PROJECT

- NOTE 1
 (A) ONE OR TWO COMPONENT SILICONE COMPARTING TO 100S.2.3 OR 100S.2.4
 (B) TAR PAPER EQUIVALENT TO 30 B.S./100 T SHALL BE PLACED BETWEEN THE BOLSTER BLOCK AND THE PAVING SLAB.
 (C) BOLSTER BLOCK SHALL BE CONSTRUCTED OF CLASS 2" OR PAVEMENT TYPE CONCRETE AND INCLUDED IN THE COST OF THE PAVEMENT.
 (D) JOINT SHALL BE FILLED WITH A PREFORMED POLYURETHANE FOAM TYPE FILLER CONFORMING TO SUBSECTION 100S.06.
 (E) SEE DETAILS FOR UNDERDRAIN FOR E-4 JOINT. (SHEET 3)

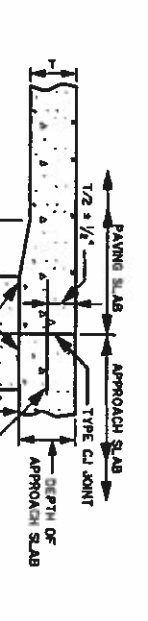
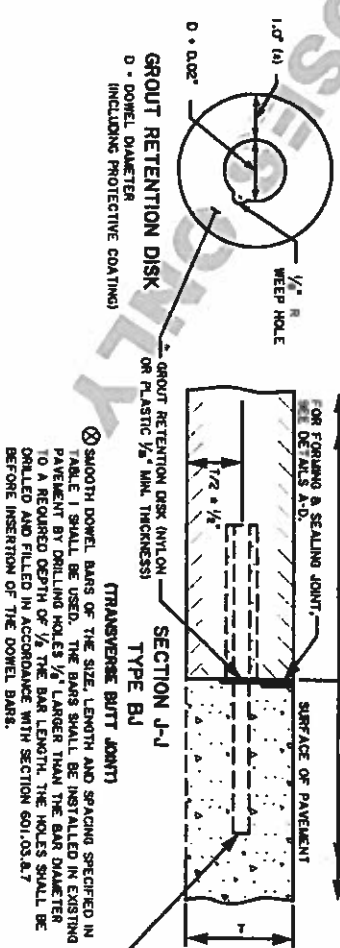
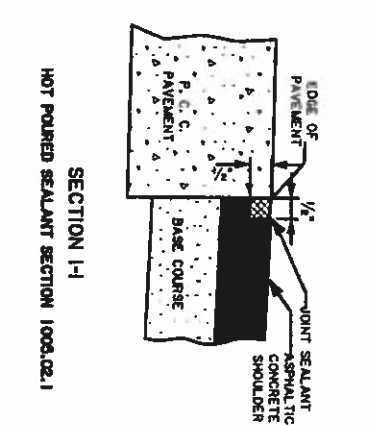
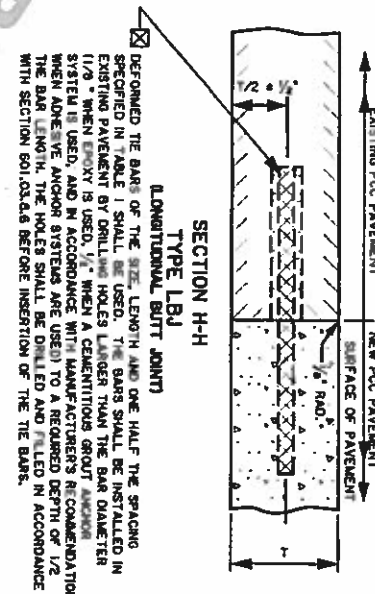
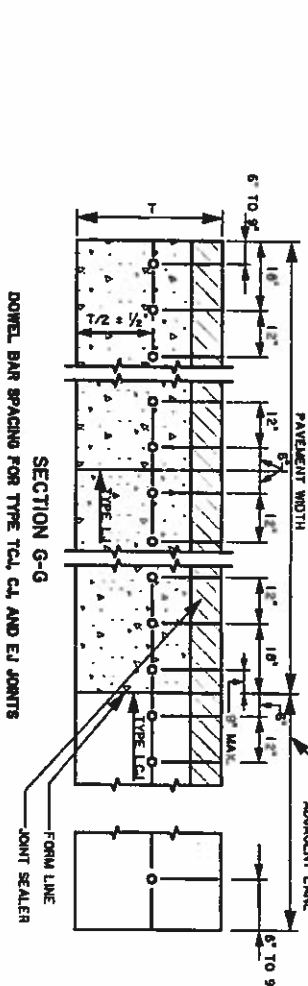
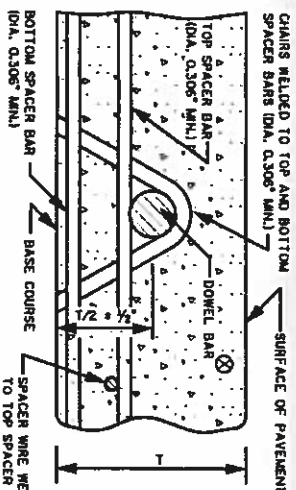
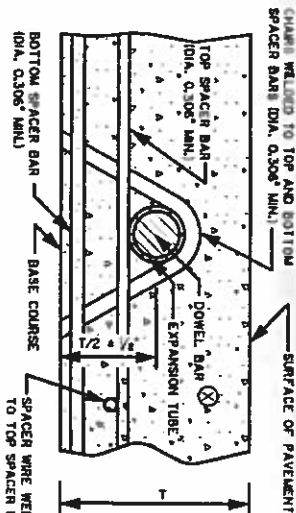
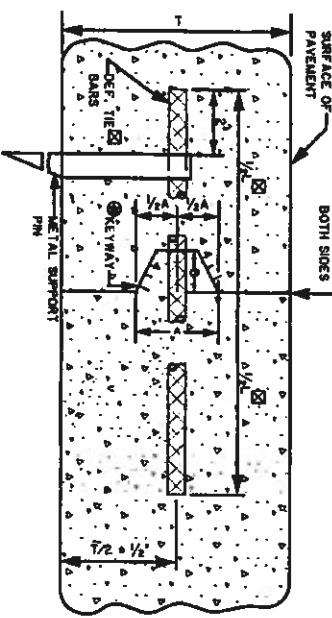
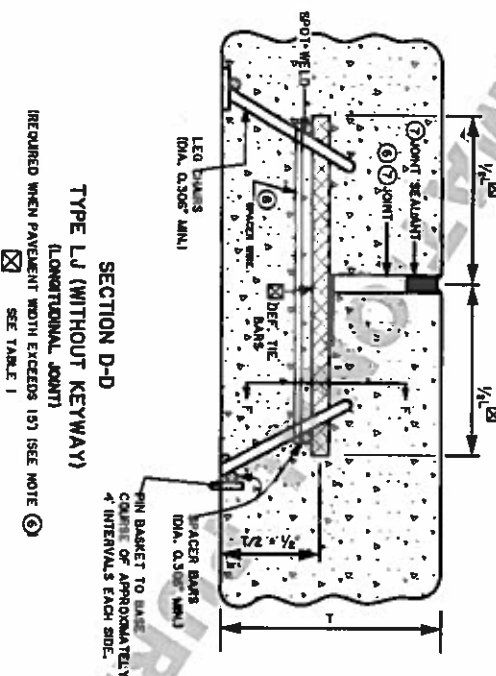
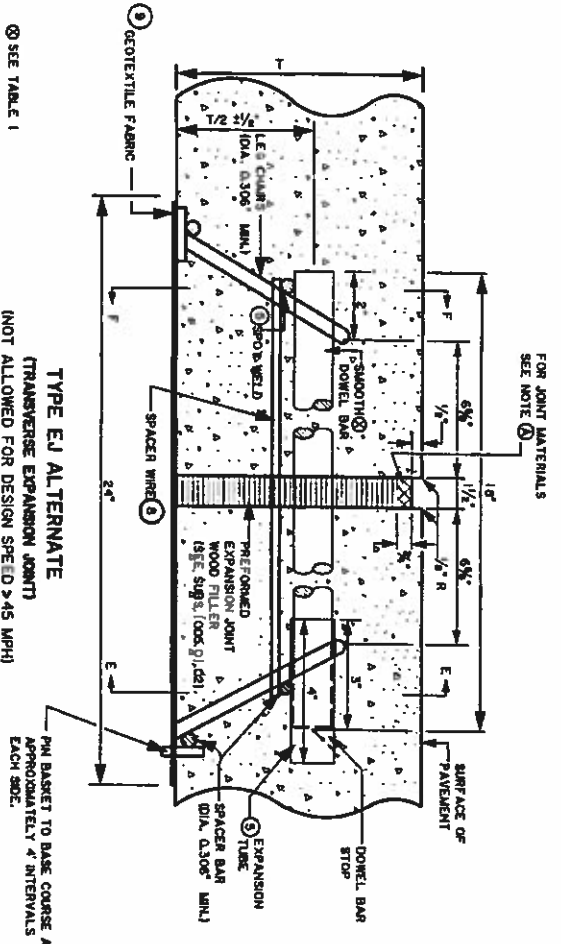
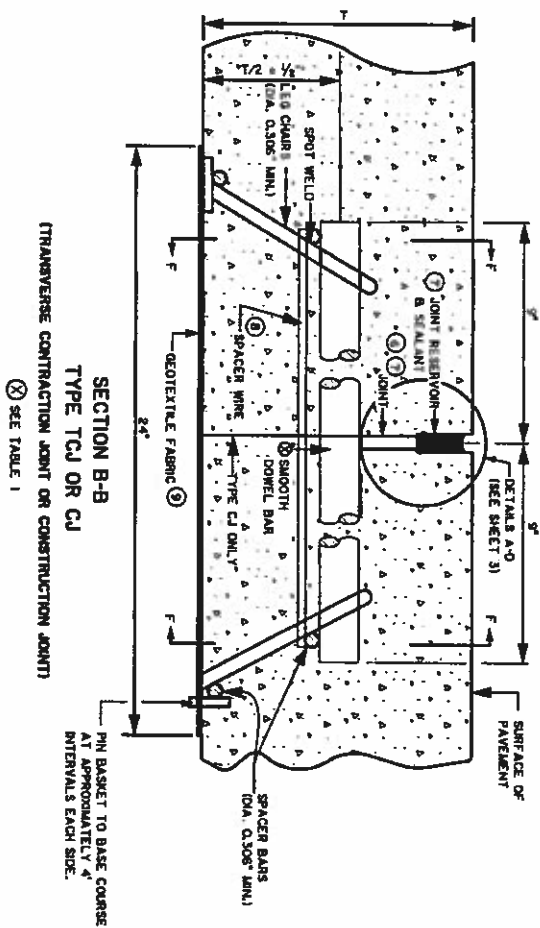
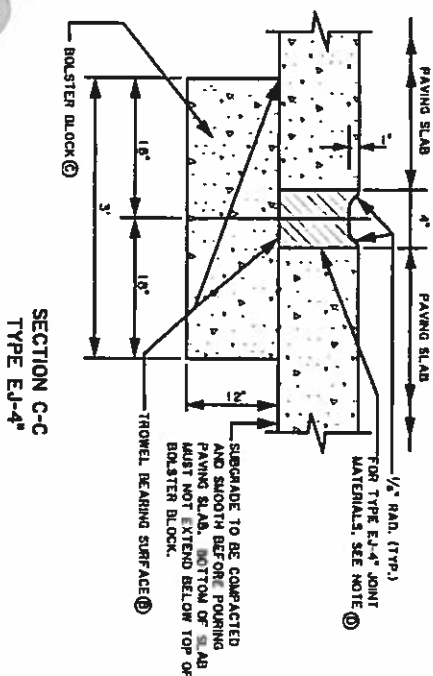
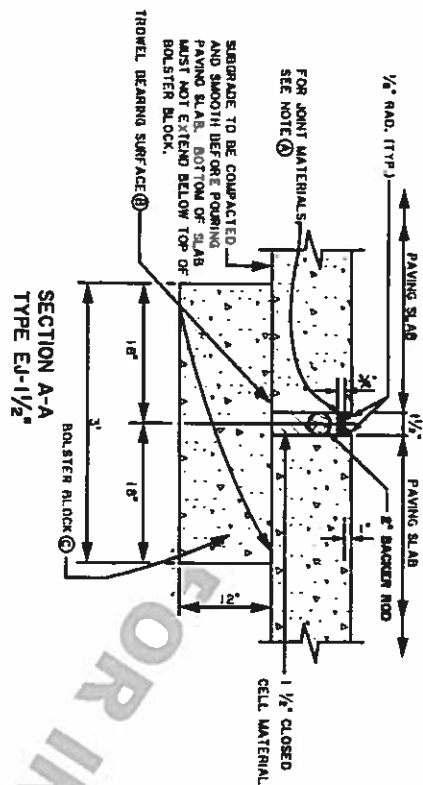

NOT TO SCALE

NOTES:
 (F) TAR PAPER EQUIVALENT TO 30 B.S./100 T SHALL BE PLACED BETWEEN THE BOLSTER BLOCK AND THE PAVING SLAB.
 (G) BOLSTER BLOCK SHALL BE CONSTRUCTED OF CLASS 2" OR PAVEMENT TYPE CONCRETE AND INCLUDED IN THE COST OF THE PAVEMENT.

PORTLAND CEMENT CONCRETE PAVEMENT DETAILS



DESIGNED	GLF	PAR:SH
CHECKED	CW	CONTROL
DATE	03/04/2013	SECTION
BY	2 OF 3	STATE
REVISION DESCRIPTION		PROJECT
APPROVED BY	Richard J. Davis	
DATE	6-3-13	

DETAILS "A-F"

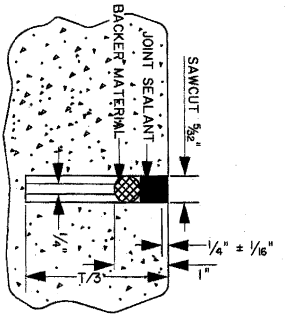

USE THIS DETAIL IN CONJUNCTION WITH TYPE TCJ (SECTION A-A) AND TYPE LCJ JOINT (SECTION D-D) AND NOTES (A) (B) (C) (D) ON SHEET #1.

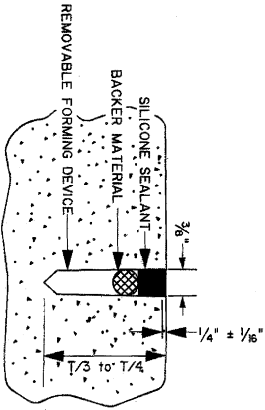

DETAIL "C"

NOT ALLOWED FOR DESIGN SPEEDS GREATER THAN 45 MPH.

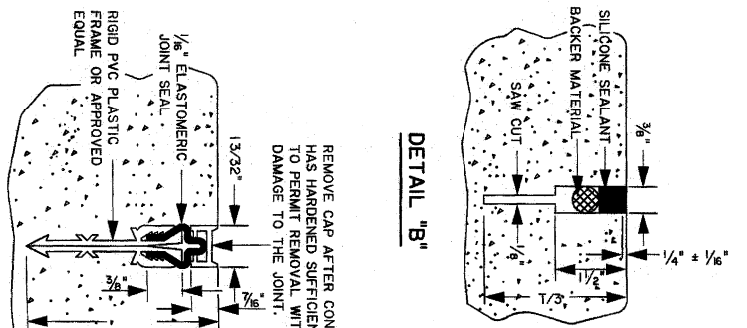

DETAIL "B"

REMOVE GAP AFTER CONCRETE HAS HARDENED SUFFICIENTLY TO PERMIT REMOVAL WITHOUT DAMAGE TO THE JOINT.

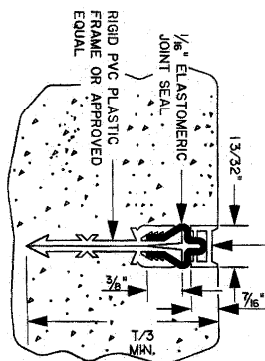

DETAIL "D"

NOT ALLOWED WHEN THE PAVEMENT IS PLACED ON PERMEABLE BASES NOT ALLOWED FOR DESIGN SPEEDS GREATER THAN 45 MPH.

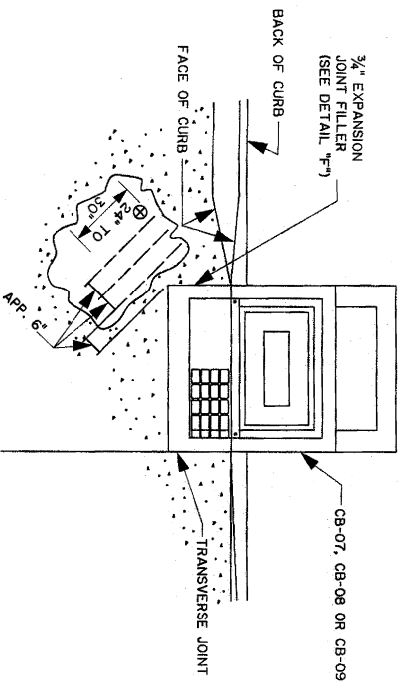

DETAIL "E"

TRANSVERSE JOINT AT CATCH BASIN

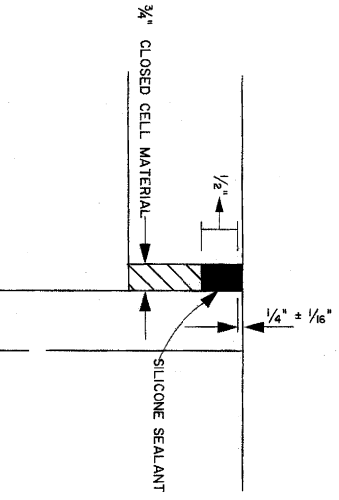

DETAIL "F"

AFTER CATCH BASIN TOP IS POURED, THE TOP OF THE 3/4" JOINT FILLER IS TO BE REMOVED TO THE DEPTH SHOWN PRIOR TO SEALING THE CURB FACES ADJACENT TO THE BASIN SHALL ALSO BE SEALED. JOINT FACES SHALL BE CLEANED IN ACCORDANCE WITH 601.13

NOTE:
WHEN CURB IS POURED MONOLITHICALLY WITH PAVEMENT, THE BITUMINOUS PREFORMED EXPANSION JOINT FILLER SHALL EXTEND TO THE TOP OF JOINT INSERT. WHEN TRANSVERSE JOINTS ARE CONSTRUCTED BY SAWING, THE INITIAL SAW CUT SHALL EXTEND THRU THE CURBED SECTION (CURB AND UNDER-LYING PAVEMENT). THE SUBSEQUENT WIDENING CUT FOR THE JOINT SEALANT RESERVOIR SHALL EXTEND INTO THE CURB FOR A DISTANCE NECESSARY TO ENSURE THE SPECIFIED RESERVOIR DEPTH IS BEING MAINTAINED AT THE GUTTER LINE. ALL CURB FACES REGARDLESS OF CURB TYPE SHALL BE SEALED WHEN TRANSVERSE JOINT IS SAWS THROUGH CURB.

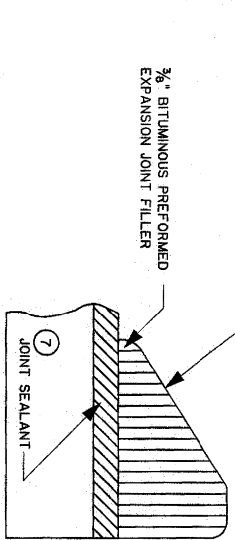

JOINT FILLER DETAIL FOR INTEGRAL CONCRETE CURB (MOUNTABLE OR BARRIER TYPE)

WHEN SLIP-FORM SYSTEM IS USED, THIS FACE TO BE TROWEL CUT TO A DEPTH OF 3" (APPROX.), THEN SCORED WITH A 1" SCORING TOOL AT 20" MAXIMUM INTERVALS OR TO MATCH ROADWAY JOINTS.

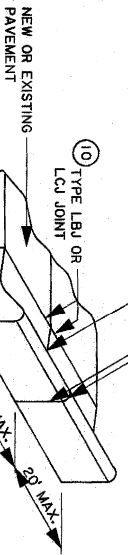

DETAIL SHOWING JOINTS IN CONCRETE CURB AND GUTTER (EXTEND ALL TCJ THROUGH CURB & GUTTER)

NOTE: SEE STANDARD PLAN DW-01AND PLANS FOR CURB PLACEMENT DETAILS.

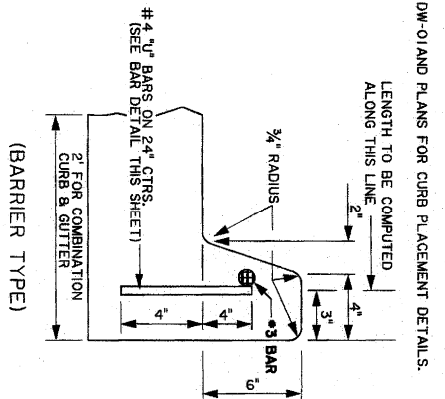

(BARRIER TYPE)

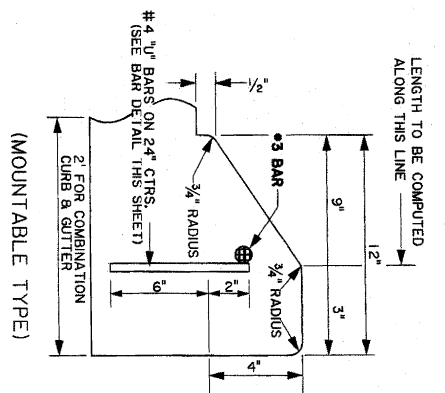

(MOUNTABLE TYPE)

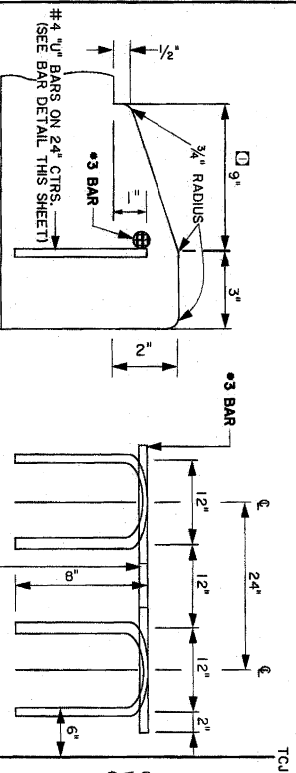

MODIFIED BARRIER OR MOUNTABLE CURB THRU DRIVEWAY

NOTE:
ALL CURB SHALL BE POURED INTEGRAL WITH PCC PAVEMENT OR GUTTER TO INSURE MONOLITHIC CONSTRUCTION UNLESS OTHERWISE APPROVED BY THE ENGINEER. CURB BARS ARE NOT REQUIRED WHERE CURB IS CONSTRUCTED MONOLITHIC WITH THE PAVEMENT. ALL BARS SHOWN SHALL BE DEFORMED REINFORCING STEEL.

CURB DETAILS

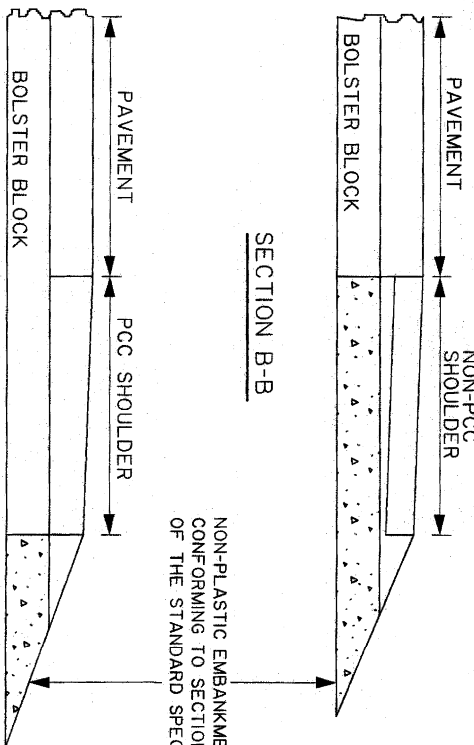

SECTION B-B

NON-PLASTIC EMBANKMENT (STONE) CONFORMING TO SECTION 1003.02.2 OF THE STANDARD SPECIFICATIONS.

SECTION B-B (WITH CONCRETE SHOULDER)

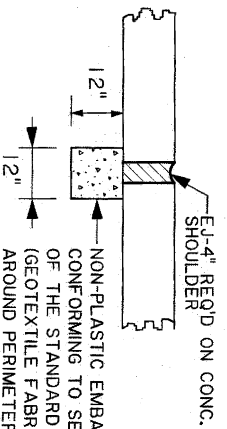

SECTION C-C

NON-PLASTIC EMBANKMENT (STONE) CONFORMING TO SECTION 1003.02.2 OF THE STANDARD SPECIFICATIONS. (GEOTEXTILE FABRIC SHALL BE PLACED AROUND PERIMETER OF STONE)

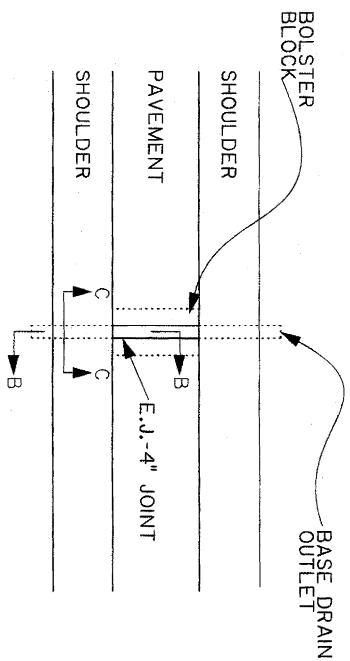

BASE DRAIN OUTLET AT 4" E.J. JOINTS

NOT TO SCALE

	<p>PORTLAND CEMENT CONCRETE PAVEMENT DETAILS</p> <p>CP-01</p>		<p>8/12/13 REVISED DIMENSION</p>	<p>C.W.</p>	<p>DESIGNED GLF</p>	<p>PARISH</p>
			<p>DATE</p>	<p>BY</p>	<p>CHECKED CW</p>	<p>CONTROL SECTION</p>
<p>APPROVED BY: <i>Richard J. Jami</i></p>			<p>REVISION DESCRIPTION</p>	<p>DATE 3/4/2013</p>	<p>SHEET 3 OF 3</p>	<p>STATE PROJECT</p>
<p>ROAD DESIGN</p>			<p>DATE: 6.3.13</p>	<p>SHEET NUMBER</p>		